

SCHEREN
SCISSORS
CISEAUX
TIJERAS
FORBICI

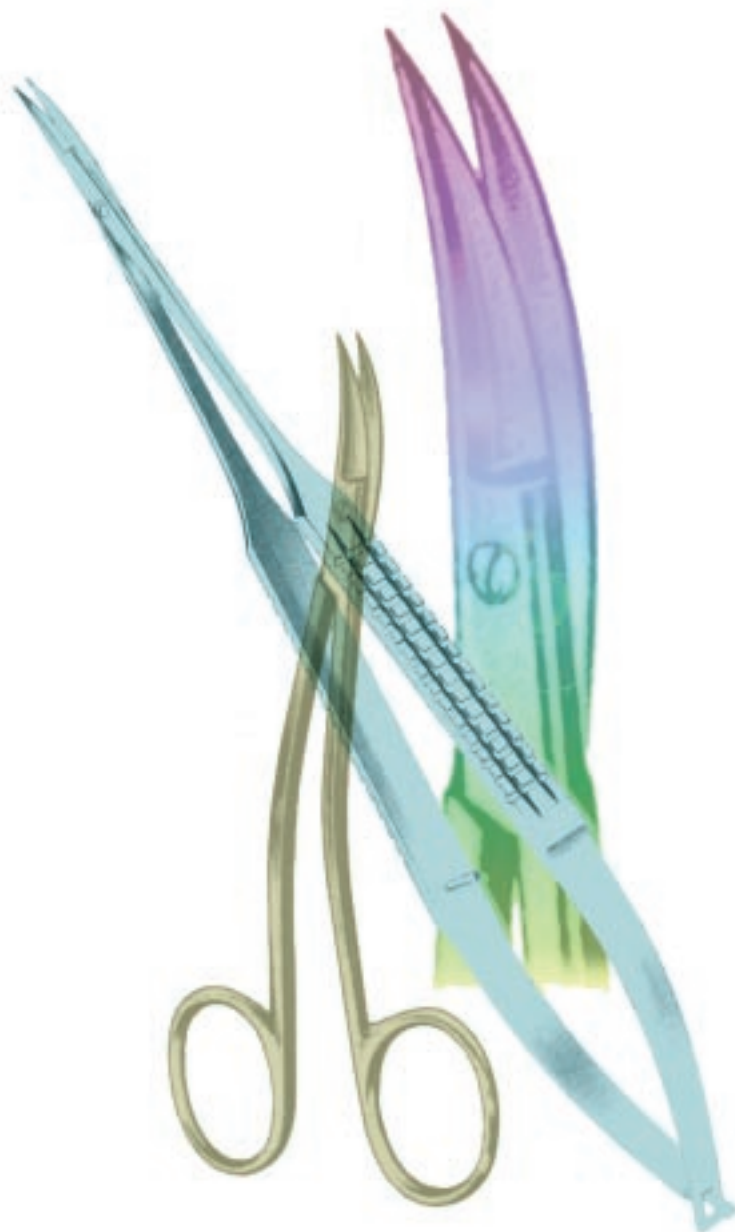

Augenschere "Ribbon type"
Eye Scissors "Ribbon type"
Ciseaux oculaires "Ribbon type"
Tijeras oculares "Ribbon type"
Forbici oculari "Ribbon type"



30.3501

RIBBON-IRIS
30.3500
9 cm



30.3503
10,5 cm

RIBBON-IRIS
30.3502
10,5 cm

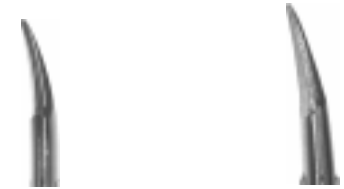

RIBBON LIGATURE **RIBBON**
30.3511 **30.3513**
10 cm 11 cm



30.3521
10 cm

RIBBON-STEVENS
30.3520
10 cm

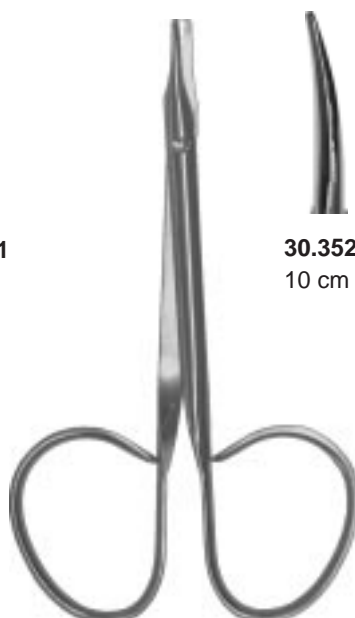

30.3523
10 cm

RIBBON-STEVENS
30.3522
10 cm



30.3541
10,5 cm

RIBBON-STRABISMUS
30.3540
10,5 cm



RIBBON-KAYE
30.3555
10,5 cm

Feine Augenschere
Fine Eye Scissors
Ciseaux oculaires fins
Tijeras oculares finas
Forbici oculari fino

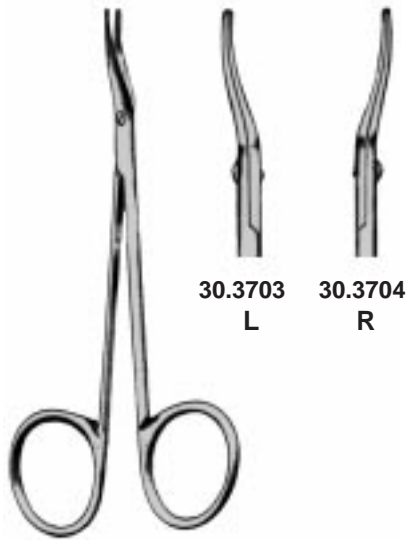

30.3703 L
30.3704 R

AEBLI
10 cm

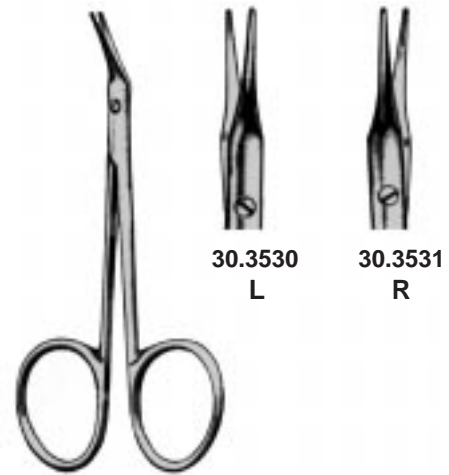

30.3530 L
30.3531 R

McGUIRE
9,5 cm



30.3552
30.3553

KNAPP
10,5 cm



30.3600
30.3600SC
30.3601
30.3601SC

BONN
9 cm

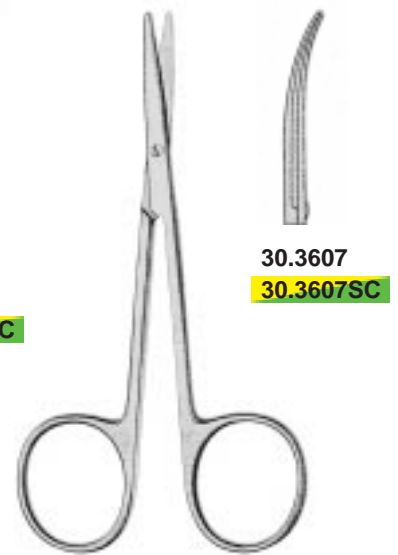

30.3607
30.3607SC

BONN-STRABISMUS
30.3606 9 cm 30.3606SC



IRIS



30.3610
9 cm



30.3611
9 cm



30.3612
10,5 cm



30.3613
10,5 cm

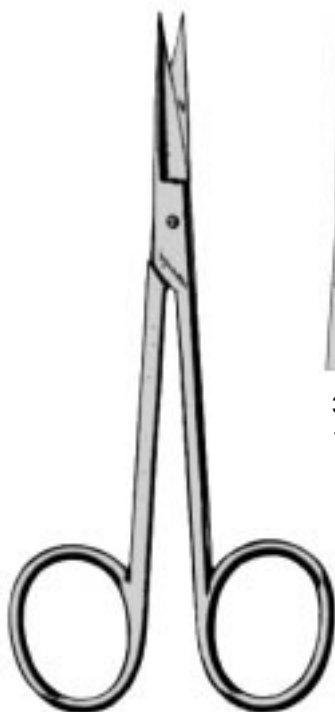

IRIS



30.3614
11,5 cm



30.3615
11,5 cm



WILMER
30.3620
10 cm



GRAEFE
30.3622
10 cm

Enukleationsscheren
Enucleation Scissors
Ciseaux à énucléation
Tijeras para enucleación
Forbici per enucleazione

Skleratomiescheren
Sclerotomy Scissors
Ciseaux à sclérotomie
Tijeras para esclerotomia
Forbici per sclerotomia

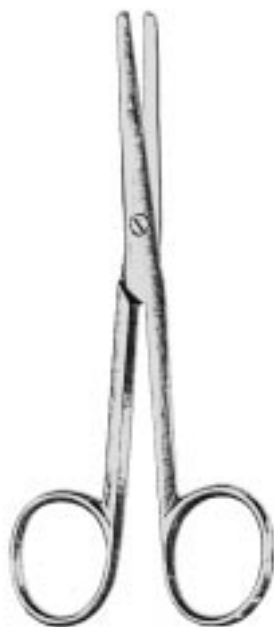

30.3660
13 cm



30.3661



30.3663



LA GRANGE
11,5 cm



30.3671
gezahnt
serrated
dentelée
dentada
dentate



30.3673
glatt
smooth
lisse
liso
piatta



MICRO-SCHERE
 30.3902
 10 cm



MICRO-SCHERE
 30.3903
 10 cm



NOYES
 12 cm



30.3910



30.3911



30.3912



30.3914



30.3915



30.3917



30.3918



aufgewinkelt
 angled up
 coudeés vers le haut
 acodadas hacia arriba
 angolate verso sopra



WECKER
11 cm



30.3920

30.3922

30.3924



BARRAQUER
5,5 cm

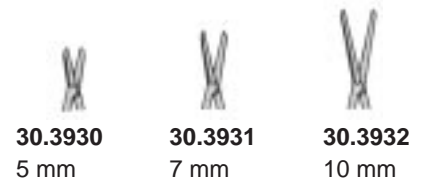

30.3930
5 mm

30.3931
7 mm

30.3932
10 mm



BARRAQUER
30.3936
11 cm



L



R



BARRAQUER
30.3938
11 cm



ONG
8,5 cm



30.3944



30.3945



WESTCOTT
11 cm



30.3951



30.3953

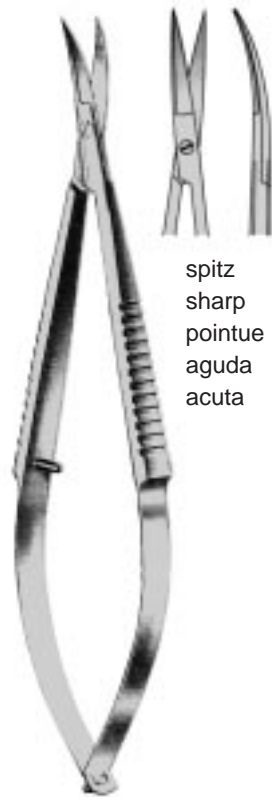

spitz
 sharp
 pointue
 aguda
 acuta

CASTROVIEJO
 30.3961
 11 cm

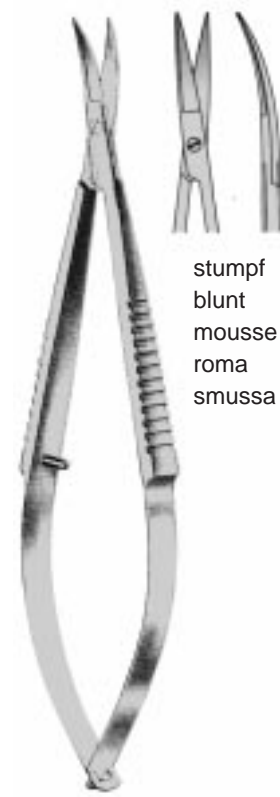

stumpf
 blunt
 mousse
 roma
 smussa

CASTROVIEJO
 30.3963
 11 cm



CASTROVIEJO
 30.3970
 11 cm



CASTROVIEJO
 30.3971



CASTROVIEJO
 30.3973



CASTROVIEJO
 30.3974



TROUTMAN
30.3975
10 cm



TROUTMAN
30.3977
10 cm



KATZIN-BARRAQUER
30.4011
10 cm



KATZIN-BARRAQUER
30.4013
10 cm



KATZIN
30.4015
11 cm



KATZIN
30.4017
11 cm

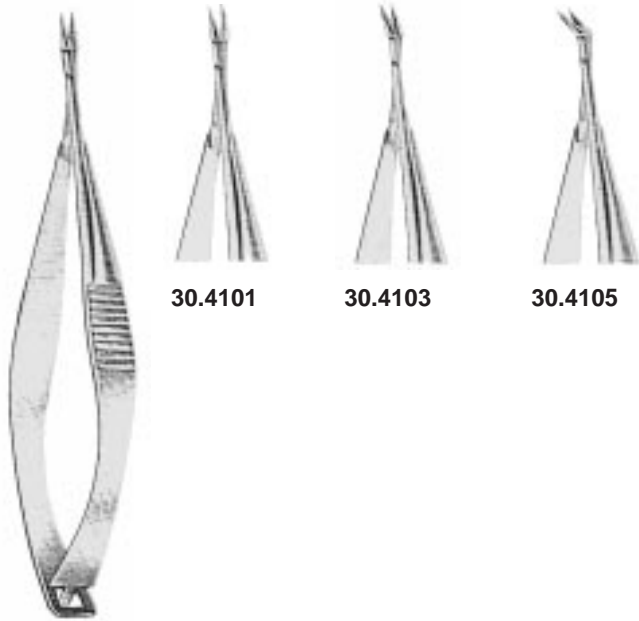

30.4101

30.4103

30.4105

VANNAS
30.4100
8 cm

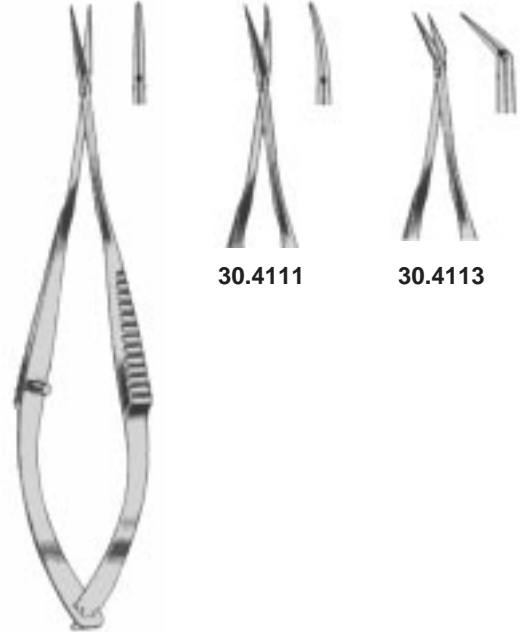

30.4111

30.4113

VANNAS-TÜBINGEN
30.4110
8,5 cm



30.4120

30.4121

COHAN-VANNAS
5,7 cm



CASTROVIEJO
30.4143
9,5 cm



CASTROVIEJO
30.4145
9,5 cm



AEBLI
30.4147
10 cm

Vitrektomie Scheren
Vitreotomy Scissors
Ciseaux à Vitrectomie
Tijeras para vitrectomia
Forbici per vitrectomia

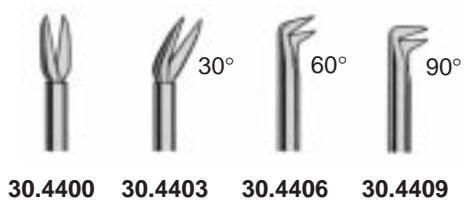
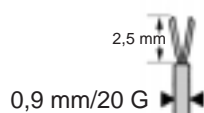

VITREKTOMIE
15 cm



28.2110
15,5 cm

VANNAS-MIKRO



28.2111
15,5 cm



28.2112
18,5 cm

VANNAS-MIKRO



28.2113
18,5 cm



28.2114
23 cm

VANNAS-MIKRO



28.2115
23 cm



VANNAS-MIKRO



28.2100 12,5 cm / Ø 7 mm
gerade
straight
droit
recto
retto

28.2101 12,5 cm / Ø 7 mm
gebogen
curved
courbe
curvo
curvo



VANNAS-MIKRO



28.2102
15 cm
Ø 8 mm
28.2104
18cm



28.2103
15 cm
Ø 8 mm
28.2105
18 cm



28.2122
15 cm / Ø 8 mm
gerade / straight /
droit / recto / retto



28.2123
15 cm / Ø 8 mm
gebogen / curved /
courbe / curvo /
curvo



28.2133
15 cm / Ø 8 mm
gebogen / curved /
courbe / curvo /
curvo

stumpf / blunt /
mousses / romas /
smusse



28.2120
12,5 cm / Ø 7mm
gerade / straight
droit / recto / retto



28.2121
12,5 cm / Ø 7 mm
gebogen / curved
courbe / curvo / curvo



28.2124
18 cm / Ø 8 mm
gerade / straight
droit / recto / retto

28.2125
18 cm / Ø 8 mm
gebogen / curved
courbe / curvo / curvo



28.2150 (GYN)
18 cm / Ø 8 mm
gerade / straight
droit / recto / retto

28.2151 (GYN)
18 cm / Ø 8 mm
gebogen / curved
courbe / curvo / curvo



28.2200
18 cm 25°



28.2201
18 cm 45°



28.2202
18 cm 60°



28.2203
18 cm 90°



28.2204
18 cm 125°



28.2210
18 cm 25°



28.2211
18 cm 45°

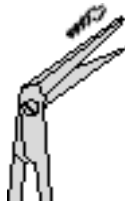

28.2212
18 cm 60°

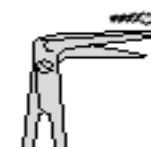

28.2213
18 cm 90°



28.2214
18 cm 125°

mit 1 geknöpften Blatt / 1 probe-pointed blade / avec 1 lame boutonée / con una punta botonada / con 1 lama abbottona



ARTERIOTOMY

TITANIUM



18 cm



28.2460
28.2460T
 25°



28.2470
28.2470T
 25°



28.2461
28.2461T
 45°



28.2471
28.2471T
 45°



28.2462
28.2462T
 60°



28.2472
28.2472T
 60°



28.2463
28.2463T
 90°



28.2473
28.2473T
 90°



28.2464
28.2464T
 125°



28.2474
28.2474T
 125°

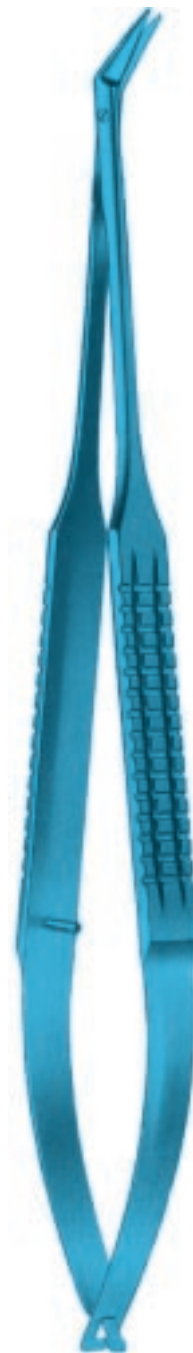

18 cm

mit 1 geknöpften Blatt
 1 probe-pointed blade
 1 lame boutonée
 1 punta botonada
 1 lame abbottona



18 cm



28.2480
25°



28.2481
45°



28.2482
60°



28.2483
90°



28.2484
125°



28.2490
25°



28.2491
45°



28.2492
60°



28.2493
90°



28.2494
125°

mit 1 geknöpften Blatt / 1 probe-pointed blade
avec 1 lame boutonée / con una punta botonada / con 1 lama abbottona



JACOBSON
16 cm



28.2220



28.2221



JACOBSON
19 cm



28.2222



28.2223



28.2225



MILLES
16 cm



28.2230



28.2231

gezahnt
serrated
dentelées
dentada
dentate



18,5 cm



28.2310



28.2311



28.2313



28.2315



23 cm



28.2350



28.2351

Venenschere
Vein Scissors
Ciseaux pour veines
Tijera para venas
Forbici per vene



BIEMER
28.2400
13 cm

TITANIUM



28.2560
28.2560T
15 cm
28.2562
28.2562T
18 cm
28.2564
28.2564T
21 cm
28.2566
23 cm



28.2561
28.2561T
15 cm
28.2563
28.2563T
18 cm
28.2565
28.2565T
21 cm
28.2567
23 cm





28.2600 16,5 cm
28.2602 20,0 cm

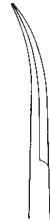

28.2601 16,5 cm
28.2603 20,0 cm



28.2605 20,0 cm



28.2608 20,0 cm



28.2609 20,0 cm



28.2620 22,5 cm



28.2623 22,5 cm
28.2625 24,5 cm



28.2624 22,5 cm

28.2622 22,5 cm
 gezahnt
 serrated
 dentelées
 dentada
 dentate



28.2628 22,5 cm



28.2629 22,5 cm



28.2640 22,5 cm



28.2641 22,5 cm

VANNAS



NAGEL

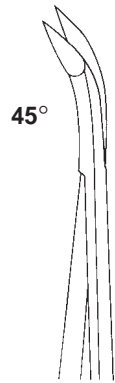

45°

28.2656 20,0 cm



45°

28.2657 20,0 cm

geknöpft
button-end
boutonée
abotonada
con 1 lama abbottona



125°

28.2659 20,0 cm



VANNAS
 28.2714 12 cm
 28.2718 16 cm



VANNAS
 28.2715 12 cm
 28.2719 16 cm



VANNAS
 28.2711 12 cm



YASARGIL
 28.2712 12 cm
 28.2716 16 cm
 28.2722 18,5 cm



YASARGIL
 28.2713 12 cm
 28.2717 16 cm
 28.2723 18,5 cm



POTTS-YASARGIL
 28.2724 18,5 cm



MILLES
 28.2720 16 cm

gezahnt/serrated
 dentelés/dentada
 dentate



MILLES
 28.2721 16 cm

gezahnt/serrated
 dentelés/dentada
 dentate















BIEMER
 28.2728 13 cm

Venenschere
 Vein Scissors
 Ciseaux pour veines
 Tijera para venas
 Forbici per vene



17,5 cm

| | Mikro-Scheren micro-scissors micro-ciseaux micro-tijeras micro-forbici | Mikro-Scheren fein micro-scissors fine micro-ciseaux fins micro-tijeras fino micro-forbici fini |
|---|--|---|
| gerade straight droites recta rette |  28.4010 |  28.4040 |
| gerade horizontal straight horizontal coupant horizontal recta horizontal rette orizzontale |  28.4012 |  28.4042 |
| aufgebogen curved up courbe vers le haut curva hacia arriba curva in alto |  28.4013 |  28.4043 |
| aufgebogen horizontal curved up horizontal coupant horizontal, courbe sur le plat curva hacia arriba horizontal curva in alto orizzontale |  28.4015 |  28.4045 |
| nach rechts gebogen curved to right courbe à droit curva a la derecha curva destra |  28.4017 |  28.4047 |
| nach links gebogen curved to left courbe à gauche curva a la izquierda curva sinistra |  28.4019 |  28.4049 |
| gerade 8 mm straight 8 mm droites 8 mm recta 8 mm retta 8 mm |  28.4020 | |

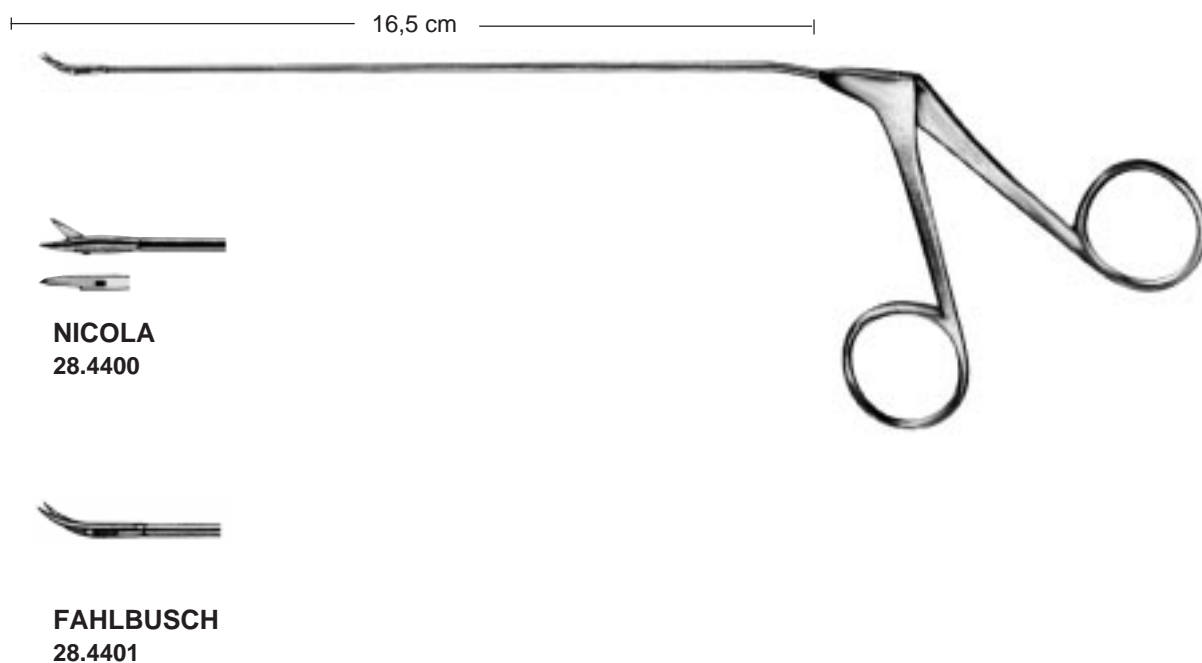
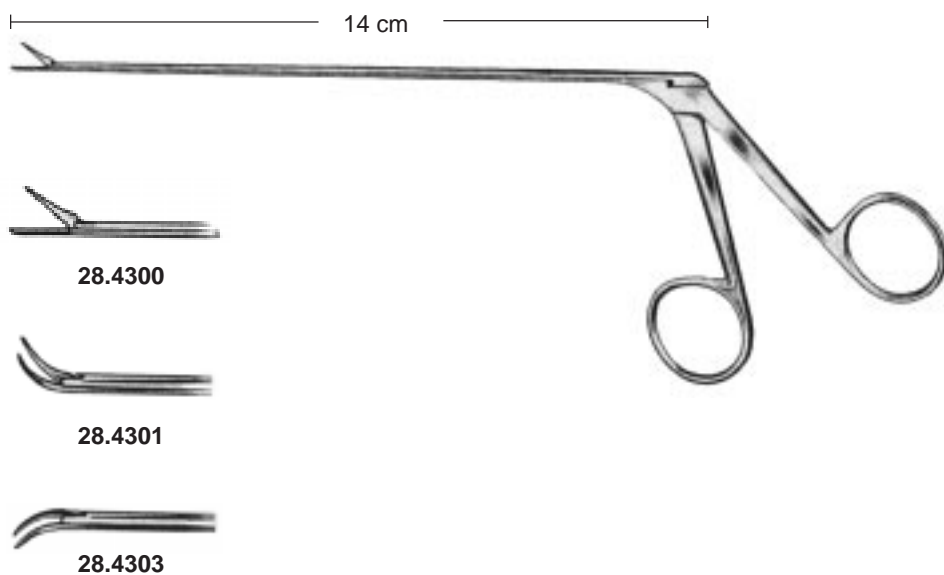



IRIS

- 13.0010 9,0 cm
- 13.0010SC** 9,0 cm
- 13.0012 10,5 cm
- 13.0012SC** 10,5 cm
- 13.0014 11,5 cm
- 13.0014SC** 11,5 cm



IRIS

- 13.0011 9,0 cm
- 13.0011SC** 9,0 cm
- 13.0013 10,5 cm
- 13.0013SC** 10,5 cm
- 13.0015 11,5 cm
- 13.0015SC** 11,5 cm



IRIS

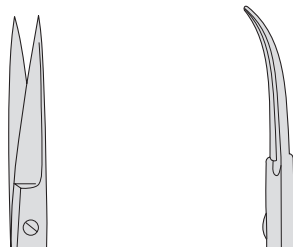

- 13.0012L 10,5 cm
- 13.0012LSC** 10,5 cm
- 13.0013L 10,5 cm
- 13.0013LSC** 10,5 cm

linkshändig / left handed /
pour gaucher / para zurdo / per mano sinistra

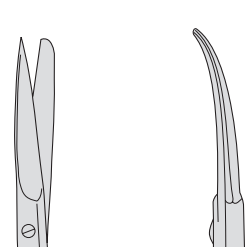

- 13.0022 10 cm
- 13.0023 10 cm



IRIS

mit grossen Ringen
 with large rings
 avec anneaux larges
 con anillos grandes
 con anelli grandi



13.0032 10 cm



13.0033 10 cm

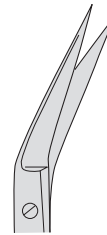

13.0041 9,0 cm

13.0043 10,5 cm

13.0043SC 10,5 cm

13.0045 11,0 cm

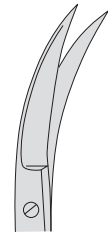

WALKER

13.0051 9,0 cm

13.0053 10,5 cm

13.0055 11,5 cm



STRABISMUS

11,5 cm



13.0060

13.0060SC



13.0061

13.0061SC



STRABISMUS

13.0062 11,5 cm



STRABISMUS

13.0063 11,5 cm



12,5 cm



13.0064



13.0065



13.0066



13.0067



13.0068



13.0069



13.0070
11 cm

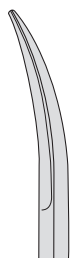

13.0071
11 cm



STEVENS



13.0076



13.0077



10,5 cm 13.0078



13.0079



13.0080

13.0081

11,5 cm

13.0082

13.0083

13.0080SC

13.0081SC

11,5 cm

13.0082SC

13.0083SC



Präparierschere
 Dissecting Scissors
 Ciseaux à dissection
 Tijera para disección
 Forbice per dissezione

POTTS
13.0089
 14 cm



DEAVER



13.0100 13 cm **13.0101**
13.0102 14 cm **13.0103**

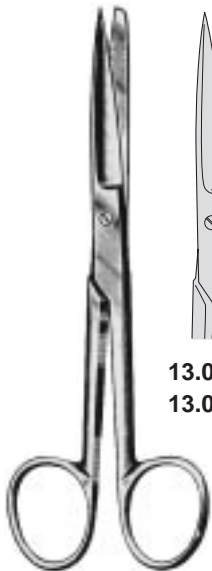

DEAVER

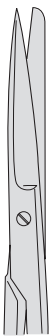

13.0110 13 cm
13.0112 14 cm

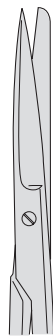

13.0111
13.0113



DEAVER



13.0122 14 cm



13.0123

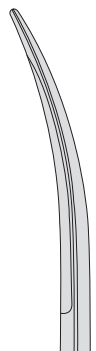



MIXTER
13.0130
15 cm



MIXTER
13.0131
15 cm



KELLY
13.0140
glatt / smooth
lisse / lisa / liscio
13.0146
gezahnt / serrated
dentées / dentadas / dentata



KELLY
13.0140SC
gerade / straight
droits / recta/ retto

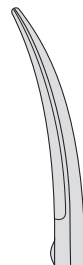

KELLY
13.0141 16 cm

13.0141SC 16 cm
glatt / smooth
lisse / lisa / liscio
13.0147
gezahnt / serrated
dentées / dentadas / dentata



INCISION
13.0292 13,0 cm
13.0294 14,5 cm



GRAZIL

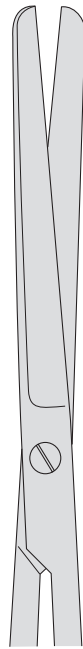

13.0152 13 cm
13.0154 14,5 cm

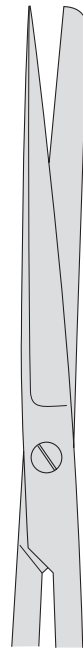

13.0162 13 cm
13.0164 14,5 cm

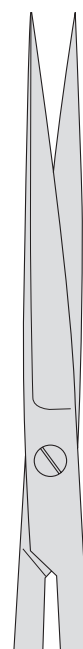

13.0172 13 cm
13.0174 14,5 cm



GRAZIL

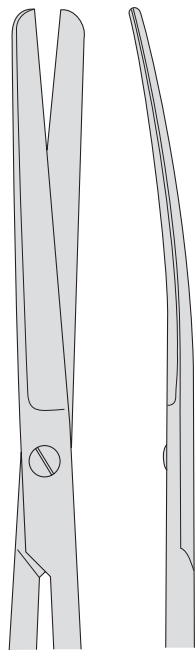

13.0153 13 cm
13.0155 14,5 cm

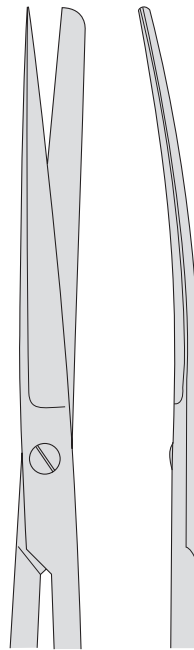

13.0163 13 cm
13.0165 14,5 cm

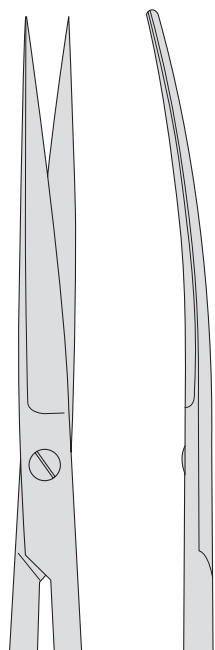

13.0173 13 cm
13.0175 14,5 cm

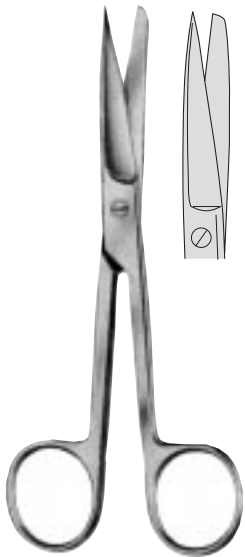

- 13.0300 11,5 cm
- 13.0302 13,0 cm
- 13.0302SC 13,0 cm
- 13.0304 14,5 cm
- 13.0304SC 14,5 cm
- 13.0306 15,5 cm
- 13.0308 16,5 cm
- 13.0308SC 16,5 cm
- 13.0310 18,5 cm
- 13.0312 20,0 cm



- 13.0304L 14,5 cm
- linkshändig
- left-handed
- pour gaucher
- para zurdo
- per mano sinistra



- 13.0394L 14.5 cm
- gezahnt
- serrated
- dentées
- dentadas
- dentata



- 13.0330 11,5 cm
- 13.0330SC 11,5 cm
- 13.0332 13,0 cm
- 13.0334 14,5 cm
- 13.0334SC 14,5 cm
- 13.0336 15,5 cm
- 13.0338 16,5 cm
- 13.0340 18,5 cm
- 13.0342 20,0 cm

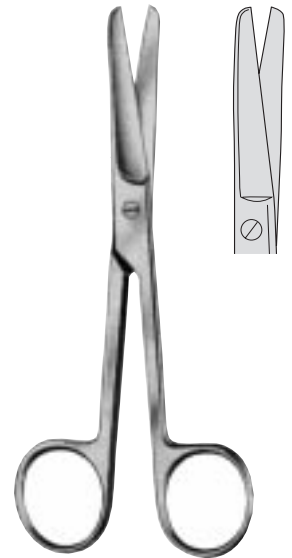

- 13.0350 11,5 cm
- 13.0352 13,0 cm
- 13.0352SC 13,0 cm
- 13.0354 14,5 cm
- 13.0354SC 14,5 cm
- 13.0356 15,5 cm
- 13.0358 16,5 cm
- 13.0358SC 16,5 cm
- 13.0360 18,5 cm
- 13.0360SC 18,5 cm
- 13.0362 20,0 cm

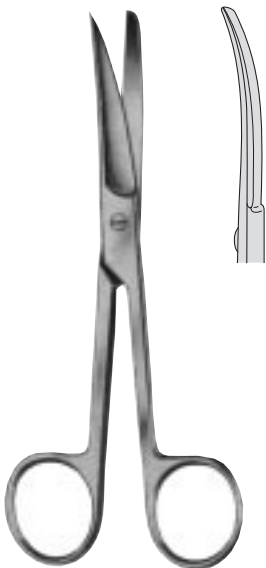

- 13.0301 11,5 cm
- 13.0303 13,0 cm
- 13.0305 14,5 cm
- 13.0307 15,5 cm
- 13.0309 16,5 cm
- 13.0311 18,5 cm
- 13.0313 20,0 cm

- 13.0301SC
- 13.0303SC
- 13.0305SC
- 13.0309SC

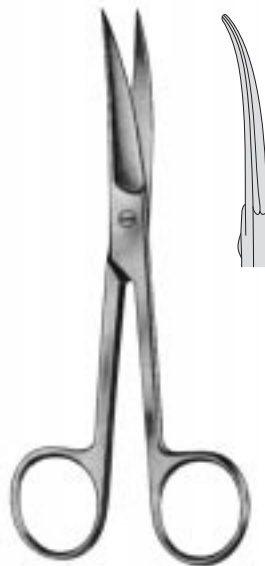

- 13.0331 11,5 cm
- 13.0333 13,0 cm
- 13.0335 14,5 cm
- 13.0337 15,5 cm
- 13.0339 16,5 cm
- 13.0341 18,5 cm
- 13.0343 20,0 cm

- 13.0333SC
- 13.0335SC

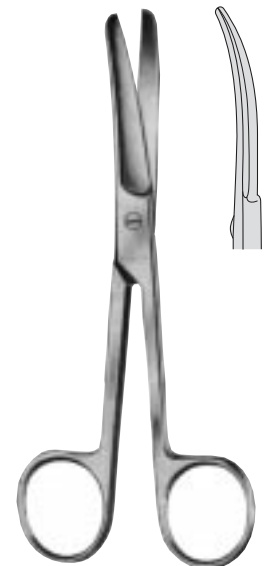

- 13.0351 11,5 cm
- 13.0353 13,0 cm
- 13.0355 14,5 cm
- 13.0357 15,5 cm
- 13.0359 16,5 cm
- 13.0361 18,5 cm
- 13.0363 20,0 cm

- 13.0355SC
- 13.0363SC



MAYO

- | | |
|------------------|---------|
| 13.0400 | 14,5 cm |
| 13.0400SC | 14,5 cm |
| 13.0402 | 15,5 cm |
| 13.0402SC | 15,5 cm |
| 13.0404 | 17,0 cm |
| 13.0404SC | 17,0 cm |
| 13.0406 | 20,0 cm |
| 13.0406SC | 20,0 cm |
| 13.0408 | 23,0 cm |
| 13.0408SC | 23,0 cm |

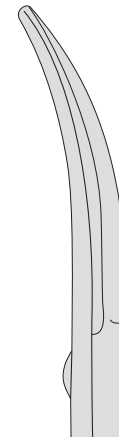

- | | |
|------------------|---------|
| 13.0401 | 14,5 cm |
| 13.0401SC | 14,5 cm |
| 13.0403 | 15,5 cm |
| 13.0403SC | 15,5 cm |
| 13.0405 | 17,0 cm |
| 13.0405SC | 17,0 cm |
| 13.0407 | 20,0 cm |
| 13.0407SC | 20,0 cm |
| 13.0409 | 23,0 cm |
| 13.0409SC | 23,0 cm |



MAYO-STILLE

- | | |
|------------------|---------|
| 13.0432 | 15,0 cm |
| 13.0432SC | 15,0 cm |
| 13.0434 | 17,0 cm |
| 13.0434SC | 17,0 cm |
| 13.0436 | 19,5 cm |
| 13.0438 | 21,0 cm |



- | | |
|------------------|---------|
| 13.0433 | 15,0 cm |
| 13.0433SC | 15,0 cm |
| 13.0435 | 17,0 cm |
| 13.0435SC | 17,0 cm |
| 13.0437 | 19,5 cm |
| 13.0439 | 21,0 cm |

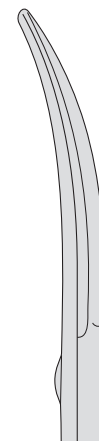

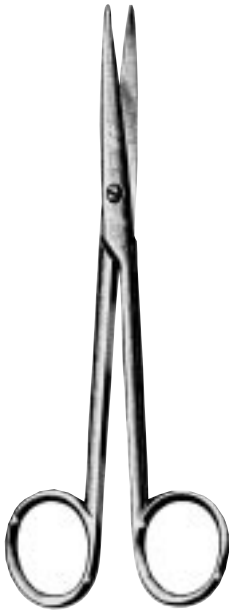

MAYO-LEXER
13.0440 16,5 cm
13.0440SC 16,5 cm

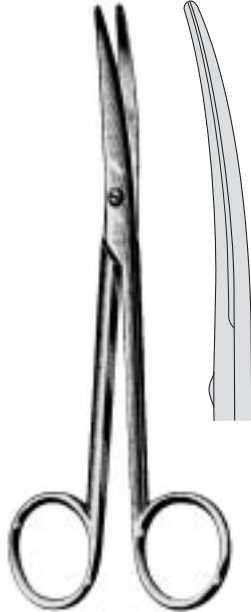

MAYO-LEXER
13.0441 16,5 cm
13.0441SC 16,5 cm



MAYO-NOBLE

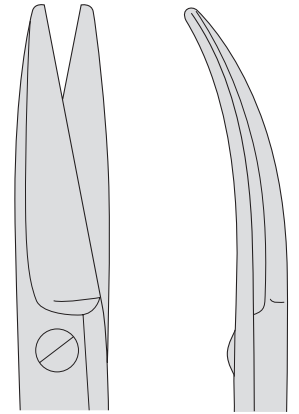

13.0462 17 cm 13.0463 17 cm

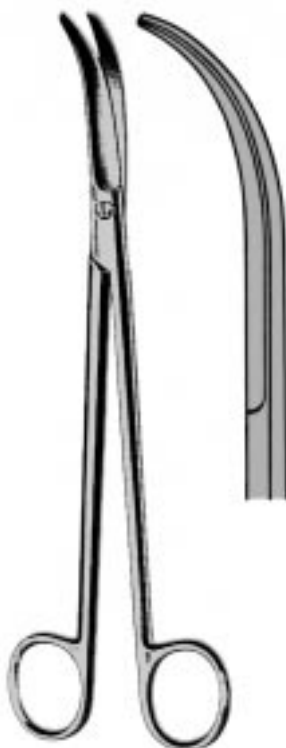

JÖRGENSON
13.0541 23 cm

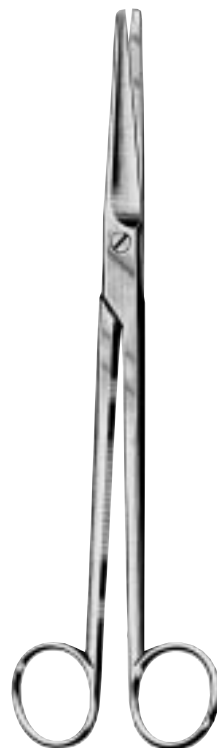

MAYO-HARRINGTON



13.0550 23 cm
13.0554 28 cm
13.0554SC 28 cm



13.0551 23 cm
13.0555 28 cm
13.0555SC 28 cm

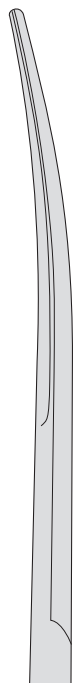



WERTHEIM

- 13.0561 14,5 cm
- 13.0562 19,5 cm
- 13.0563 22,5 cm



THOREK

- 13.0565 19 cm
- 13.0567 23 cm



LEXER-BABY

13.0700
10 cm

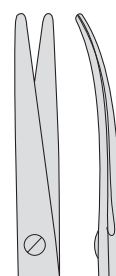

10.0701
10 cm



METZENBAUM-BABY

- 13.0594 11,5 cm
- 13.0594SC 11,5 cm
- 13.0596 13,0 cm
- 13.0598 14,5 cm
- 13.0598SC 14,5 cm

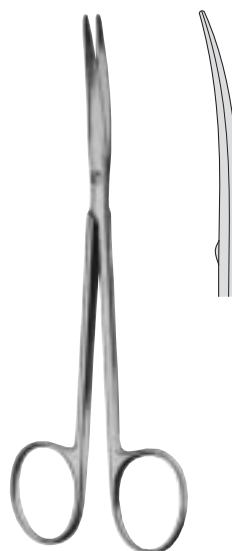

METZENBAUM-BABY

- 13.0595 11,5 cm
- 13.0595SC 11,5 cm
- 13.0597 13,0 cm
- 13.0599 14,5 cm
- 13.0599SC 14,5 cm



METZENBAUM
14,5 cm



13.0600

13.0600L

linkshändig/left-handed/
pour gaucher/para zurdo/
per mano sinistra

13.0600SC



13.0620



13.0640



13.0601

13.0601L

linkshändig/left-handed/
pour gaucher/para zurdo/
per mano sinistra

13.0601SC



13.0621

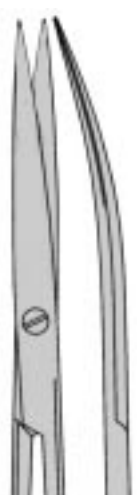

13.0641



LAHEY-METZENBAUM



13.0752
15 cm

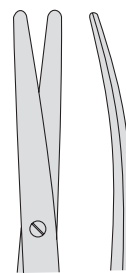

13.0753
15 cm



stumpf - stumpf
 blunt - blunt
 mousses - mousses
 romo - romo
 smusso - smusso



spitz - stumpf
 sharp - blunt
 pointu - mousses
 agudo - romo
 appuntato - smusso



METZENBAUM

| | | |
|----------------|---------|------------------|
| 13.0602 | 18,0 cm | 13.0602SC |
| 13.0604 | 20,0 cm | 13.0604SC |
| 13.0606 | 23,0 cm | 13.0606SC |
| 13.0608 | 25,0 cm | 13.0608SC |
| 13.0610 | 28,0 cm | 13.0610SC |
| 13.0612 | 30,0 cm | 13.0612SC |

METZENBAUM

| | | |
|----------------|---------|------------------|
| 13.0603 | 18,0 cm | 13.0603SC |
| 13.0605 | 20,0 cm | 13.0605SC |
| 13.0607 | 23,0 cm | 13.0607SC |
| 13.0609 | 25,0 cm | 13.0609SC |
| 13.0611 | 28,0 cm | 13.0611SC |
| 13.0613 | 30,0 cm | 13.0613SC |

METZENBAUM

| | |
|----------------|---------|
| 13.0622 | 18,0 cm |
| 13.0624 | 20,0 cm |
| 13.0626 | 23,0 cm |
| 13.0628 | 25,0 cm |
| 13.0630 | 28,0 cm |

METZENBAUM

| | |
|----------------|---------|
| 13.0623 | 18,0 cm |
| 13.0625 | 20,0 cm |
| 13.0627 | 23,0 cm |
| 13.0629 | 25,0 cm |
| 13.0631 | 28,0 cm |



spitz - spitz
 sharp - sharp
 pointu - pointu
 agudo - agudo
 appuntato - appuntato

METZENBAUM

| | | |
|----------------|---------|------------------|
| 13.0642 | 18,0 cm | |
| 13.0644 | 20,0 cm | 13.0644SC |
| 13.0646 | 23,0 cm | |
| 13.0648 | 25,0 cm | |
| 13.0650 | 28,0 cm | 13.0650SC |



METZENBAUM

| | | |
|----------------|---------|------------------|
| 13.0643 | 18,0 cm | |
| 13.0645 | 20,0 cm | 13.0645SC |
| 13.0647 | 23,0 cm | |
| 13.0649 | 25,0 cm | |
| 13.0651 | 28,0 cm | 13.0651SC |



METZENBAUM-FINO

- 13.0660 14,5 cm **13.0660SC**
- 13.0662 18,0 cm **13.0662SC**
- 13.0664 20,0 cm **13.0664SC**
- 13.0666 23,0 cm **13.0666SC**

METZENBAUM-FINO

- 13.0661 14,5 cm **13.0661SC**
- 13.0663 18,0 cm **13.0663SC**
- 13.0665 20,0 cm **13.0665SC**
- 13.0667 23,0 cm **13.0667SC**

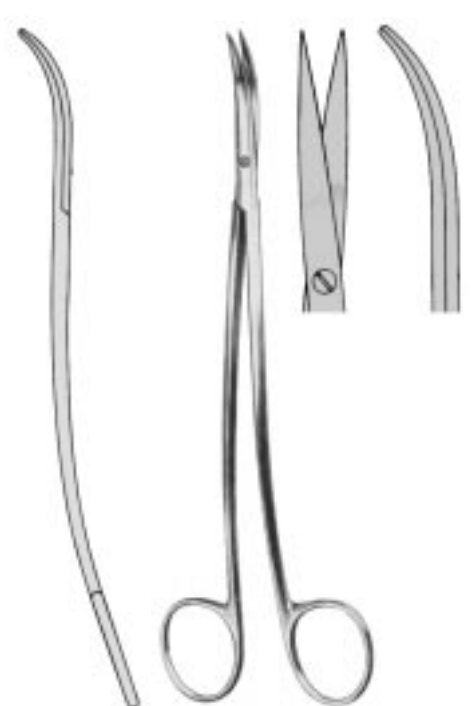

METZENBAUM-FINO

- 13.0670 14,5 cm
- 13.0672 18,0 cm
- 13.0674 20,0 cm
- 13.0676 23,0 cm

METZENBAUM-FINO

- 13.0671 14,5 cm
- 13.0673 18,0 cm
- 13.0675 20,0 cm
- 13.0677 23,0 cm

METZENBAUM-FINO

- 13.0683 18,0 cm
- 13.0685 20,0 cm
- 13.0687 23,0 cm

METZENBAUM-FINO

- 13.0693 18,0 cm
- 13.0695 20,0 cm
- 13.0697 23,0 cm

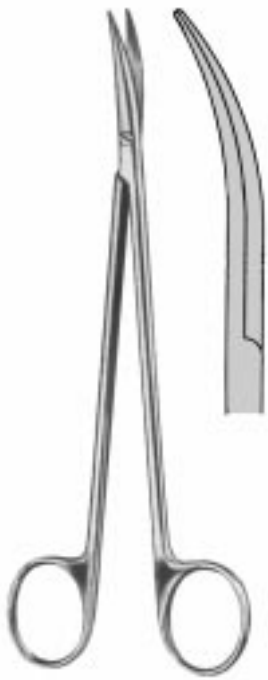

DE BAKEY
 13.0757 17 cm



TOENNIS

13.0760
 18 cm



13.0761
 18 cm



TOENNIS-ADSON
 13.0765 18 cm
 13.0765SC 18 cm



JAMESON-WERBER
 13.0779 13 cm

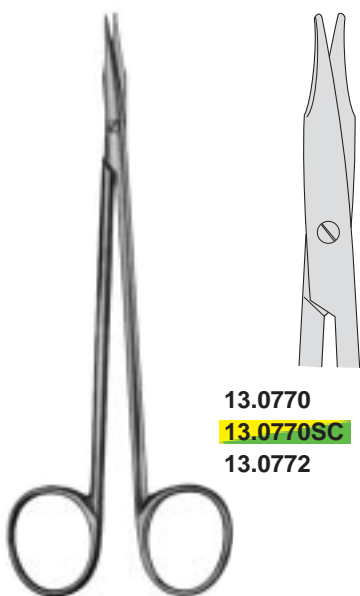

REYNOLDS

13.0770 15 cm
 13.0770SC 15 cm
 13.0772 18 cm

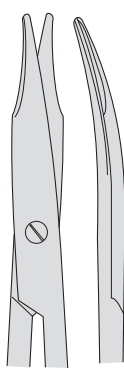
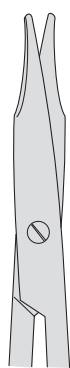

13.0771 15 cm
 13.0771SC 15 cm
 13.0773 18 cm
 13.0775 20 cm



JAMESON
 13.0780
 15 cm
 gerade/straight/droits/recto/retto



13.0781
 13.0781SC 15 cm
 gebogen
 curved
 courbe
 curvo
 curvo



PECK-JOSEPH
14 cm

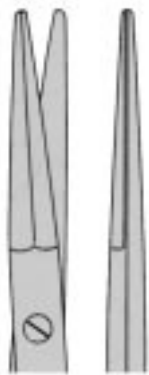

13.0790

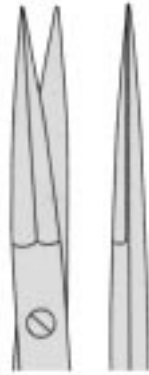

13.0792

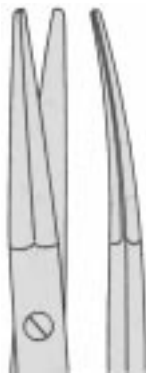

13.0791

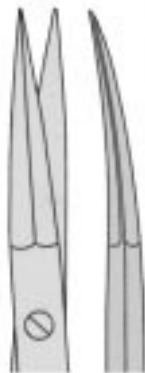

13.0793



GOLDMAN-FOX
13 cm



13.0800
13.0800SC

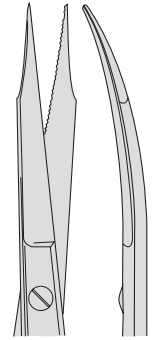

13.0801
13.0801SC



WAGNER
12 cm

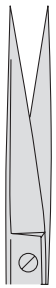

13.0820

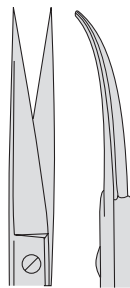

13.0821
13.0821SC

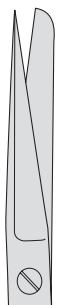

13.0822

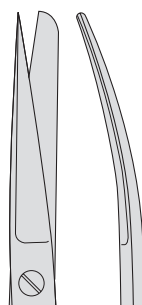

13.0823



13.0830
gezahnt
serrated
dentée
dentada
dentate

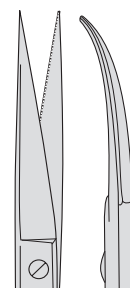

13.0831
gezahnt
serrated
dentée
dentada
dentate



13.0833



LOCKLIN
13.0840
16 cm

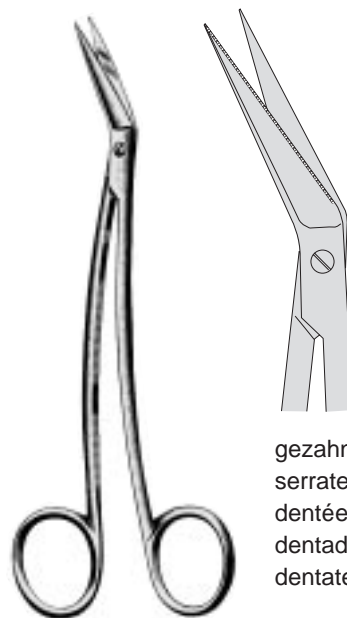

gezahnt
serrated
dentée
dentada
dentate

LOCKLIN
13.0842
16 cm



GORNEY



13.3010
12,5 cm



13.3014
19,0 cm



13.3015
19,0 cm



13.1018 9,5 cm



13.1020 11 cm



BOWMAN

13.1030 11,5 cm

geknöpft/ probe-pointed/ boutonée / botonada / bottonuta

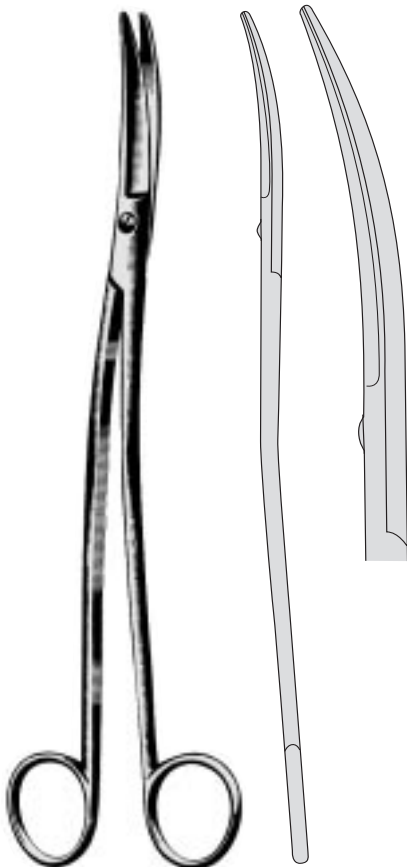

KLINGENBERG-LOTH

13.0575 23 cm

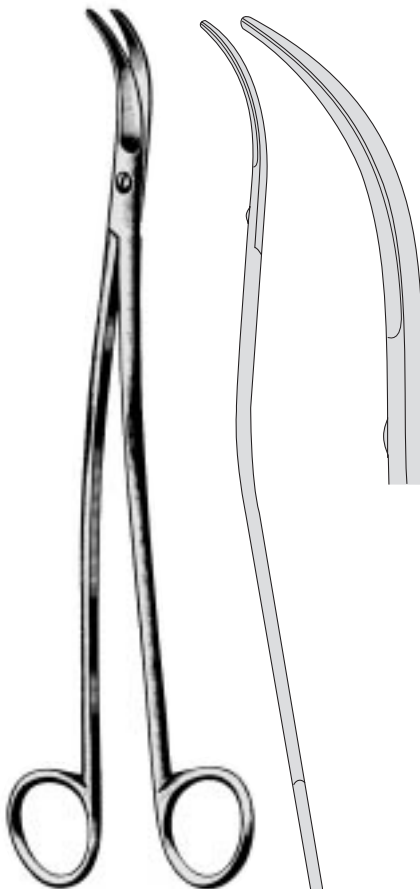

SATINSKY

13.0577 24,5 cm

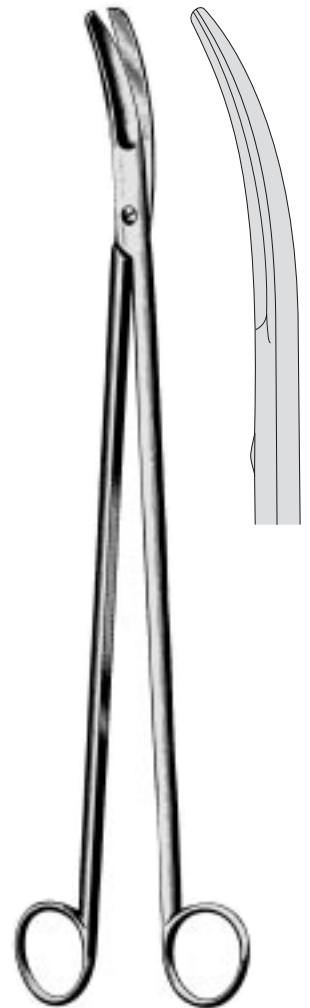

CRAFOORD

13.1081 30 cm

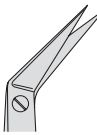

**HEGEMANN-
DIETRICH**

- | | | | |
|---|-----------------------------|---|-----------------------------|
|  | 13.1090 13,5 cm /25° |  | 13.1091 13,5 cm /45° |
| | 13.1100 19,0 cm /25° | | 13.1101 19,0 cm /45° |

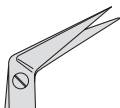
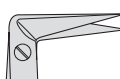
- | | | | |
|---|-----------------------------|---|-----------------------------|
|  | 13.1092 13,5 cm /60° |  | 13.1093 13,5 cm /90° |
| | 13.1102 19,0 cm /60° | | 13.1103 19,0 cm /90° |

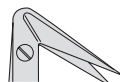



- | | |
|---|------------------------------|
|  | 13.1094 13,5 cm /120° |
| | 13.1104 19,0 cm /120° |



HEGEMANN
13.1105 19 cm 125°

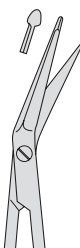

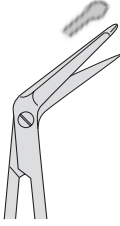
ARTERIOTOMY

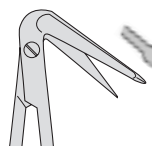
- | | |
|---|------------------------------|
|  | 13.1110 18 cm 25° |
|  | 13.1111 18 cm 45° |
|  | 13.1112 18 cm 60° |
|  | 13.1113 18 cm 90° |
|  | 13.1114 18 cm 125° |

geknöpft/ probe-pointed/ boutonée / botonada / bottonuta

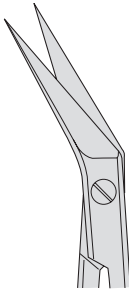
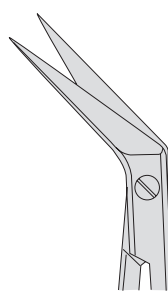
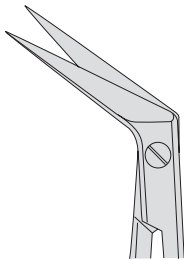

POTTS-SMITH

- | | | | |
|---|---|---|---|
|  | 13.1130 13.1130SC 19 cm 25° |  | 13.1131 13.1131SC 19 cm 45° |
| | |  | 13.1132 13.1132SC 19 cm 60° |



POTTS-SMITH
13.1133
 19 cm



DEBAKEY

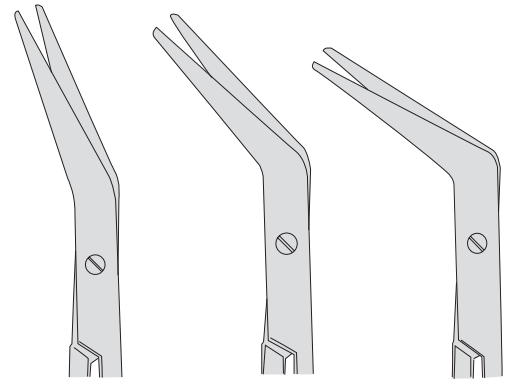

13.1150
 16 cm 25°
13.1160
 23 cm 25°

13.1151
 16 cm 45°
13.1161
 23 cm 45°

13.1152
 16 cm 60°
13.1162
 23 cm 60°

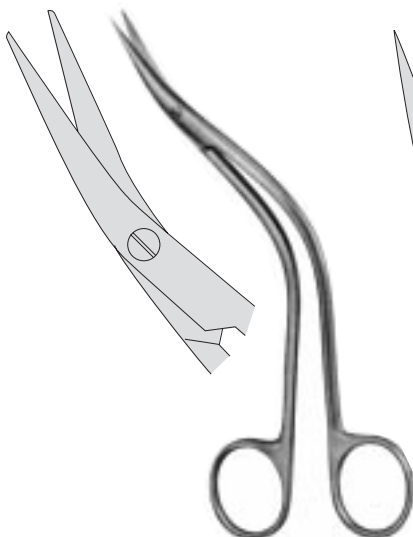

DEBAKEY
13.1165
 16 cm 25°



DEBAKEY
13.1166
 16 cm 45°



FAVOLORO
13.1170 15 cm



POTTS-DE-MARTEL

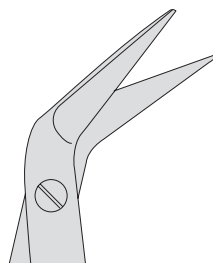

13.1180 21 cm /60°
13.1182 24 cm /60°



MILLS

13.1190 18 cm /60°
13.1192 22 cm /60°

- 1 Blatt geknöpft
- 1 probe-pointed blade
- 1 lame noutonée
- 1 hoja botonada
- 1 lama abbottona



SCHMIEDEN-TAYLOR
 13.2010 17 cm



DANDY
 13.2021 17 cm



13.2041 15 cm

13.2040 15 cm
 Nerv-Präparierschere
 nerve dissecting scissors
 ciseaux à nerfs
 tijeras para nervios
 forbici per nervi trigemino, anche nasale

Trigemini-Schere, auch für Nase
 Trigeminal- and Nasal Scissors
 Ciseaux pour le nerf trigéminal et pour le nez
 Tijera para nervio trigémino y para la nariz
 forbici per nervo trigemino, anche nasale

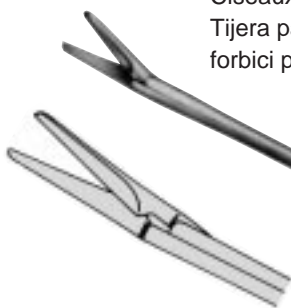

OLIVECRONA
 13.2060 23 cm



STRULLY
 13.2070 22 cm



ENTEROTOMY
13.2170 21 cm



ENTEROTOMY
13.2172 21 cm



ENTEROTOMY
13.2174 21 cm



MILLER
13.2181 17 cm



LLOYD-DAVIS
13.2183 27 cm

STELZNER
27 cm

13.2189 32 cm

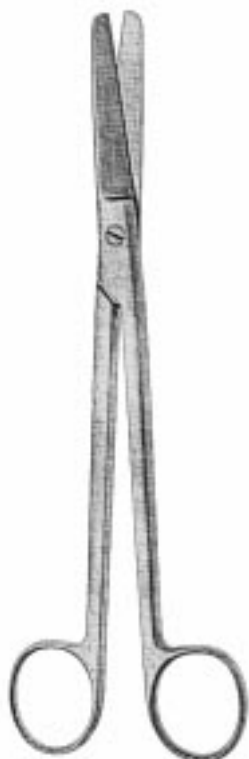

13.2101 20 cm **13.2101SC**
 13.2103 23 cm **13.2103SC**



SIMS

13.2100 20 cm **13.2100SC**
 13.2102 23 cm **13.2102SC**

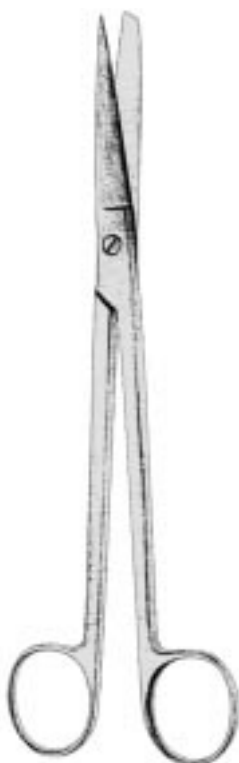

13.2111 20 cm
 13.2113 23 cm

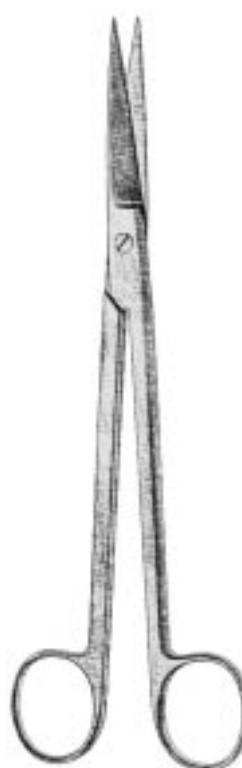

SIMS
 13.2120 20 cm



13.2121 20 cm

SIMS

13.2110 20 cm
 13.2112 23 cm



FERGUSON
 13.2134 18 cm

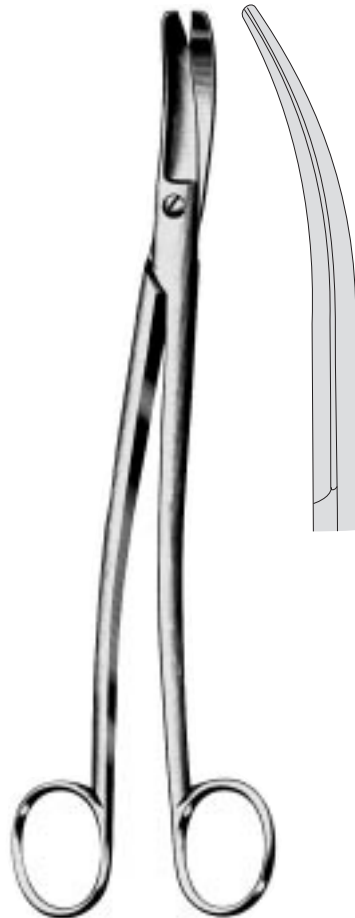

SIEBOLD
 13.2150 24 cm



BOZEMANN
 13.2155 21 cm



DOYEN
 13.2160 18 cm

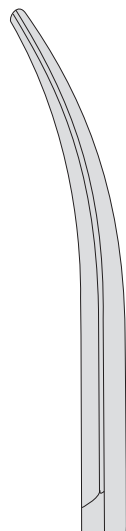

13.2161 18 cm



BRAUN-STADLER
 13.2200 14 cm
 13.2202 22 cm
 Episiotomy

Nabelschnurscheren
 Umbilical scissors
 Ciseaux pour section de
 cordon
 Tijeras umbilicales
 Forbici ombelicali



SCHUMACHER
 13.2210 15 cm

Nabelschnurscheren
 Umbilical scissors
 Ciseaux pour section de cordon
 Tijeras umbilicales
 Forbici ombelicali



SCHUMACHER
 13.2210 15 cm



UMBILICAL-USA
 13.2220 10 cm



BUSCH
 13.2232 16 cm

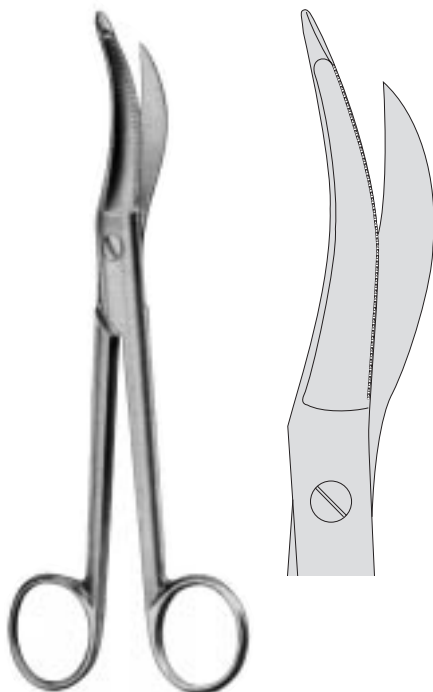

WALDMAN
 13.2240 18 cm **13.2240SC**
 13.2244 20 cm
 Episiotomy

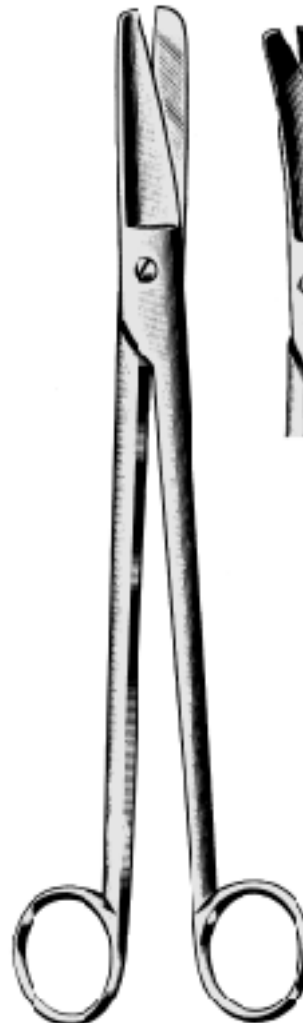

Kephalatomiescheren
 Decapitating scissors
 Ciseaux à détroncation
 Tijeras para decapitación
 Forbici per decapitazione

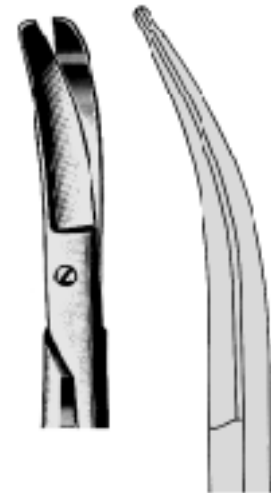

56.0601 27 cm

DUBOIS
 56.0600 27 cm



SPENCER

13.2300 9,0 cm
13.2304 10,5 cm
13.2302 13,0 cm



SPENCER

13.2301 9 cm
13.2303 13 cm



LITTAUER

13.2310 14 cm

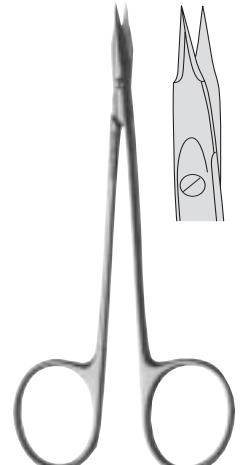

GRADLE

13.2320 9,5 cm
13.2322 12,5 cm



O'BRIEN

13.2340 9,5 cm



EISELBERG

13.2350 12 cm



SCHOEMAKER-LOTH

13.2356 13 cm

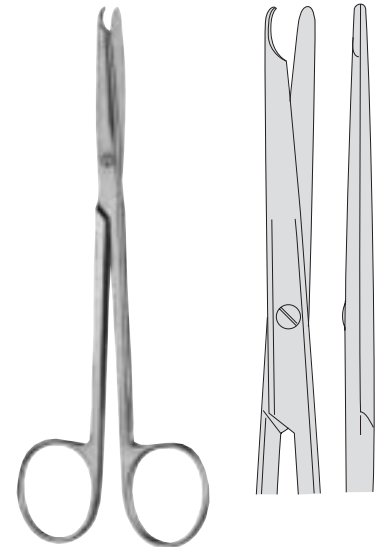

BUCK

13.2360 14,5 cm



HARVEY

13.2400 13 cm



UNIVERSAL

13.2401 12 cm

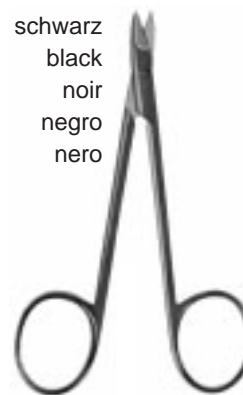

schwarz
black
noir
negro
nero

GUILFORD

13.2404 10 cm

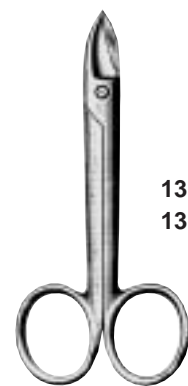

BEEBEE

13.2420 10,0 cm
13.2424 12,5 cm



HEYMANN
 13.2700 18 cm



KIRSTEIN
 13.2705 17 cm
 gezahnt
 serrated
 dentée
 dentada
 dentate



FOMON-DORSAL
 13.2726 15 cm **13.2726SC**



FOMON
 13.2740 13 cm

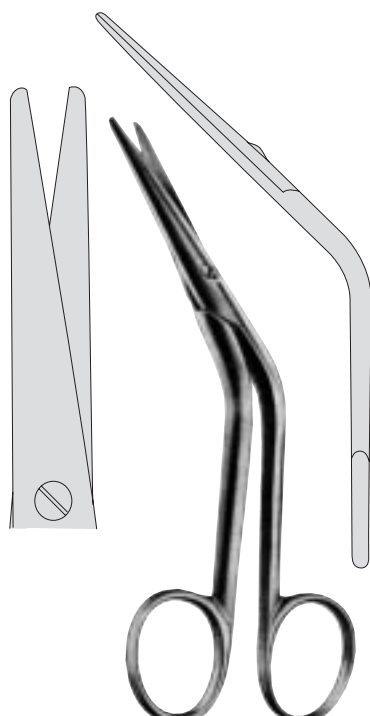

COTTLE-DORSAL
 13.2750 15 cm **13.2750SC**

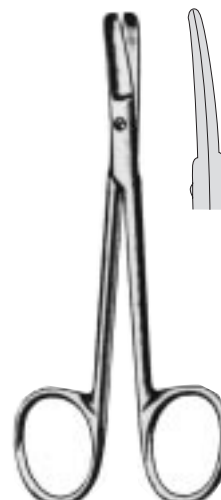

COTTLE-BULLDOG
 13.2757 11,5 cm

gezahnt / serrated / dentelées / dentada / dentate



13.2770 gerade / straight
 droit / recto / retto



13.2771 rechts gebogen / curved right
 courbe à droite / curvo por
 derecho / curvo a destra



13.2773 links gebogen / curved left
 courbe à gauche / curvo por
 izquierdo / curvo a sinistra

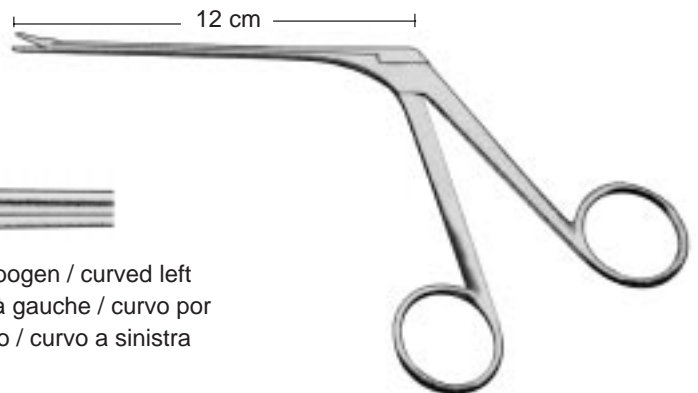

COTTLE-MASING
 10,5 cm



13.2791



13.2793

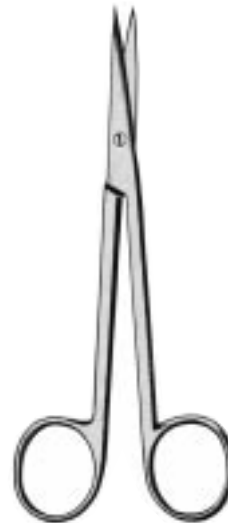

KILNER
13.2800
 12,5 cm



KILNER
13.2801
 12,5 cm

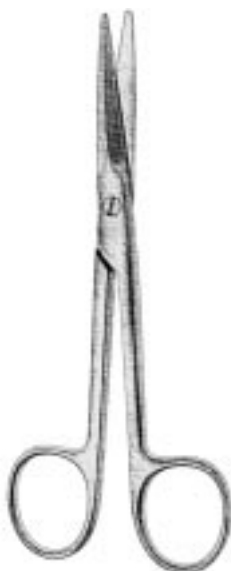

AUFRICHT
 15 cm

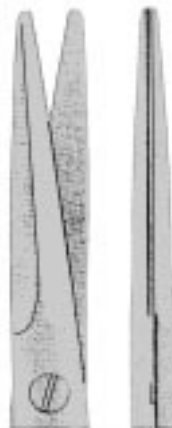

13.2810

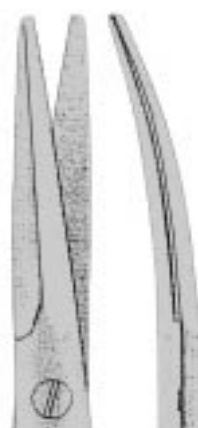

13.2811



LITTLER
13.2821 12 cm
13.2823 14 cm

gezahnt / serrated / dentée / dentada / dentate



KAYE
 13.2831 14,5 cm
 13.2835 18,0 cm



KAYE
 13.2833 14,5 cm



KAYE
 13.2845 12,0 cm



KILNER (RAGNELL)
 12 cm



13.2850
13.2850SC
 13.2850L



13.2851
13.2851SC
 13.2851L



13.2853 15 cm
 13.2855 18 cm

linkshändig/left-handed/pour gaucher/
 para zurdo/per mano sinistra



SANVENERO
13.2858
 14 cm



SANVENERO
13.2859
 14 cm



BROPHY
13.2860 14 cm

13.2862 14 cm
 gezahnt / serrated /
 dentelées / dentada / dentate



BROPHY
13.2861 14 cm

13.2863 14 cm
 gezahnt / serrated /
 dentelées / dentada / dentate



JOSEPH
13.2866 14 cm **13.2866SC**

13.2868 14 cm
 gezahnt / serrated /
 dentelées / dentada / dentate

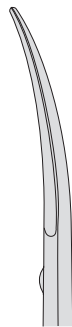

13.2867 14 cm **13.2867SC**

13.2869 14 cm
 gezahnt / serrated /
 dentelées / dentada / dentate

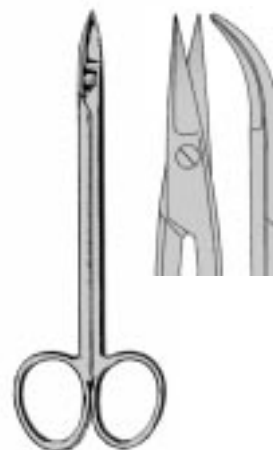

QUINBY
13.2870 12,5 cm

gezahnt / serrated /
 dentelées / dentada / dentate

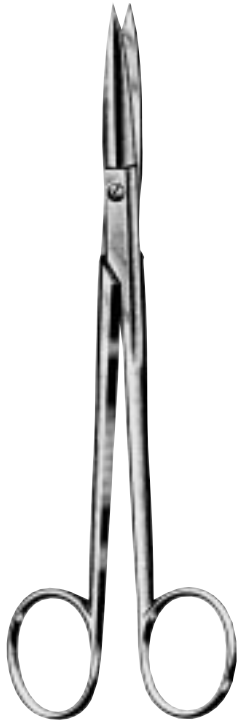

MCINDOE
13.2890 19 cm



DEAN
13.2901 17 cm
glatt/smooth
lisse/lisa/liscio
13.2903 17 cm,
gezahnt/serrated
dentée/dentada/
dentate

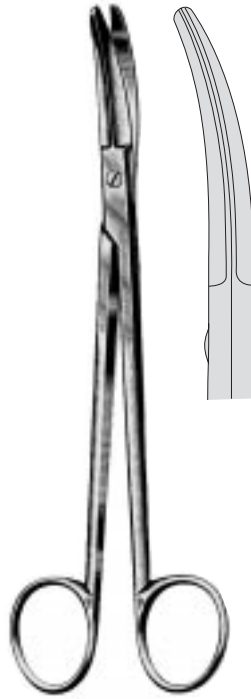

BOETTCHER
13.2925 18 cm

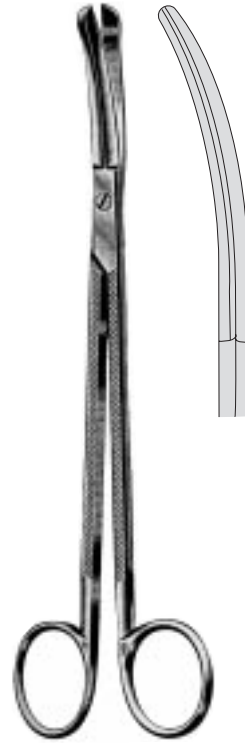

GOOD
13.2930 19 cm
glatt/smooth
lisse/lisa/liscio
13.2932 19 cm,
gezahnt/serrated
dentée/dentada/
dentate

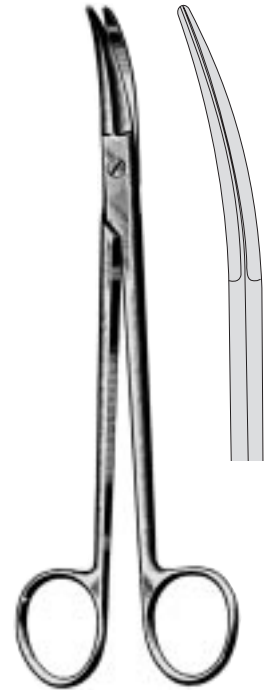

PRINCE
13.2941 17 cm



CAPLAN
33.0222
22 cm

Septumscheren
Septum Scissors
Ciseaux par la cloison nasale
Tijeras para el tabique nasal
Forbici per il setto nasale



GORNEY (KILLIAN)
33.0250
21 cm

Kropfschere/Goitre Scissors/
Ciseaux à goitre/Tijeras para bocio/
Forbice per gozzo



SCHOEMAKER
36.0400
15 cm

Speichelgangschere/Salivary Gland Scissors/
Ciseaux pour voie salivaire/
Tijeras para el canal salivar/
Forbice per condotto saliva



PERWITZSCHKY
33.2901
11,5 cm

Knorpelscheren
Cartilage Scissors
Ciseaux pour le cartilage
Tijeras para cartilago
Forbici per cartilagini



MARTIN
23.3320
20 cm

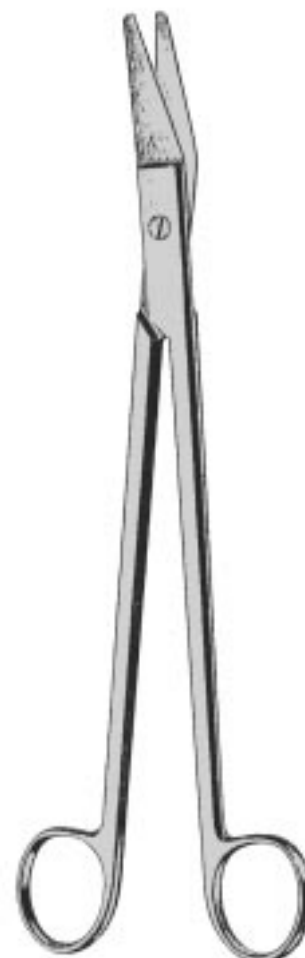

RESANO
23.3325
25 cm



IRIS
13.5000
11,5 cm

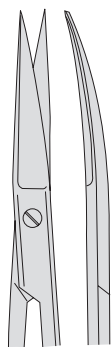

IRIS
13.5001
11,5 cm



IRIS
13.5007
11,5 cm



STRABISMUS
13.5010
11,5 cm



STRABISMUS
13.5011
11,5 cm



GOLDMAN-FOX
13.5020
13 cm

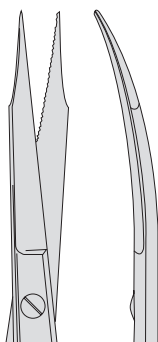

GOLDMAN-FOX
13.5021
13 cm



BABY-LEXER
13.5030
10 cm



BABY-LEXER
13.5031
10 cm



RAGNELL
13.5041
11,5 cm



STANDARD

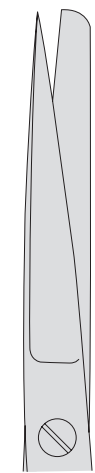

13.5100
14,5 cm
13.5102
16,5 cm

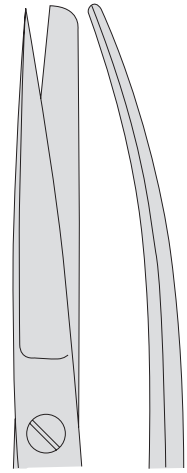

13.5101
14,5 cm
13.5103
16,5 cm

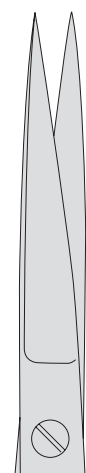

13.5110
14,5 cm

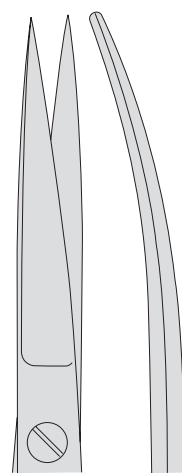

13.5111
14,5 cm

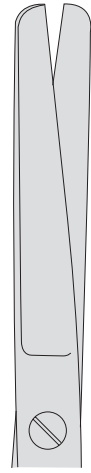

13.5120
14,5 cm

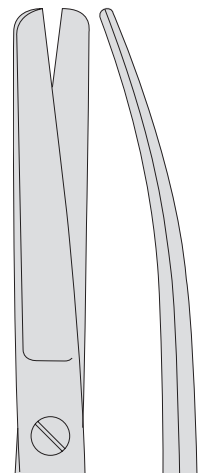

13.5121
14,5 cm



MAYO

13.5200 14,5 cm
13.5202 17 cm
13.5204 23 cm



MAYO

13.5201 14,5 cm
13.5203 17 cm
13.5205 23 cm



MAYO-STILLE

13.5210 15 cm
13.5212 17 cm

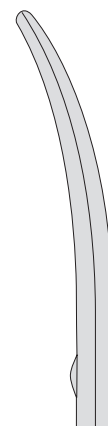

MAYO-STILLE

13.5211 15 cm
13.5213 17 cm

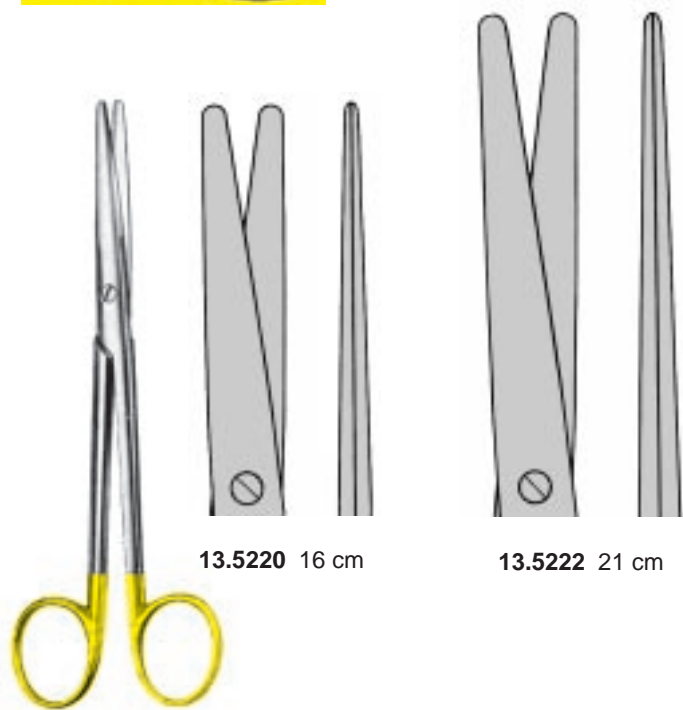

13.5220 16 cm

13.5222 21 cm

MAYO-LEXER

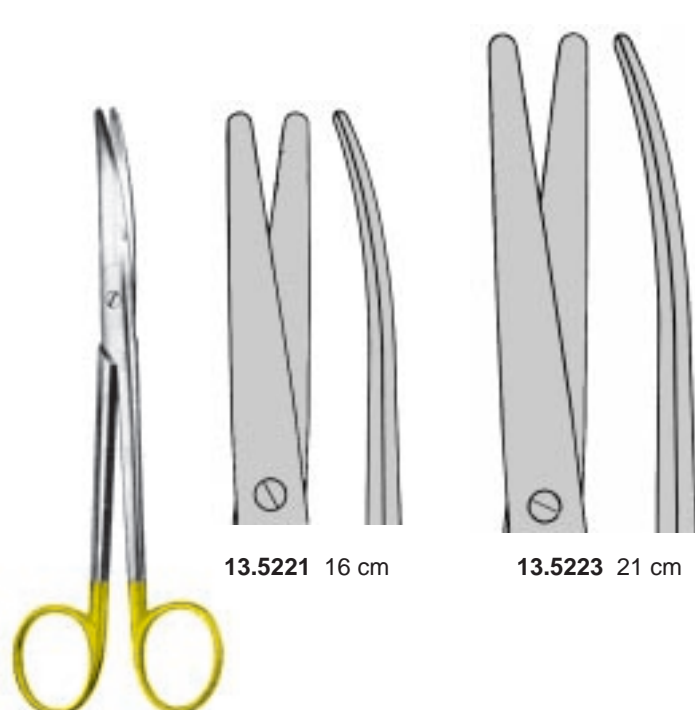

13.5221 16 cm

13.5223 21 cm

MAYO-LEXER



MAYO-HARRINGTON
 13.5241 23 cm
 13.5243 28 cm

MAYO-HARRINGTON

13.5240 23 cm
 13.5242 28 cm

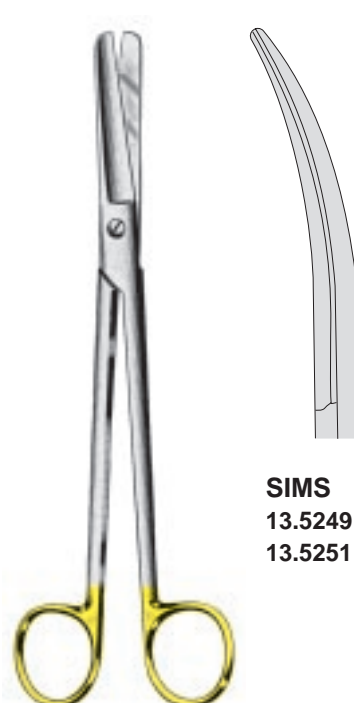

SIMS
 13.5249 20 cm
 13.5251 23 cm

SIMS

13.5248 20 cm
 13.5250 23 cm



PARAMETRIUM

23 cm



13.5255



13.5259



BLESSING

13.5281

30 cm

Schere für Rektumchirurgie
Scissors for rectal surgery
Ciseaux pour chirurgie rectale
Tijera para la cirugía del recto
Forbici per la chirurgia rettale

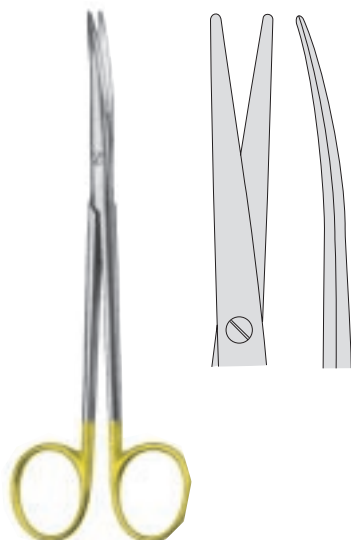

TOENNIS-ADSON
13.5291 17,5 cm



METZENBAUM

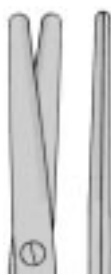

13.5298
11,5 cm

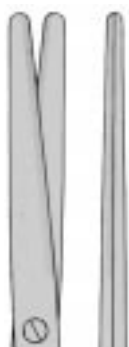

13.5300
14,5 cm



METZENBAUM



13.5299
11,5 cm



13.5301
14,5 cm



METZENBAUM

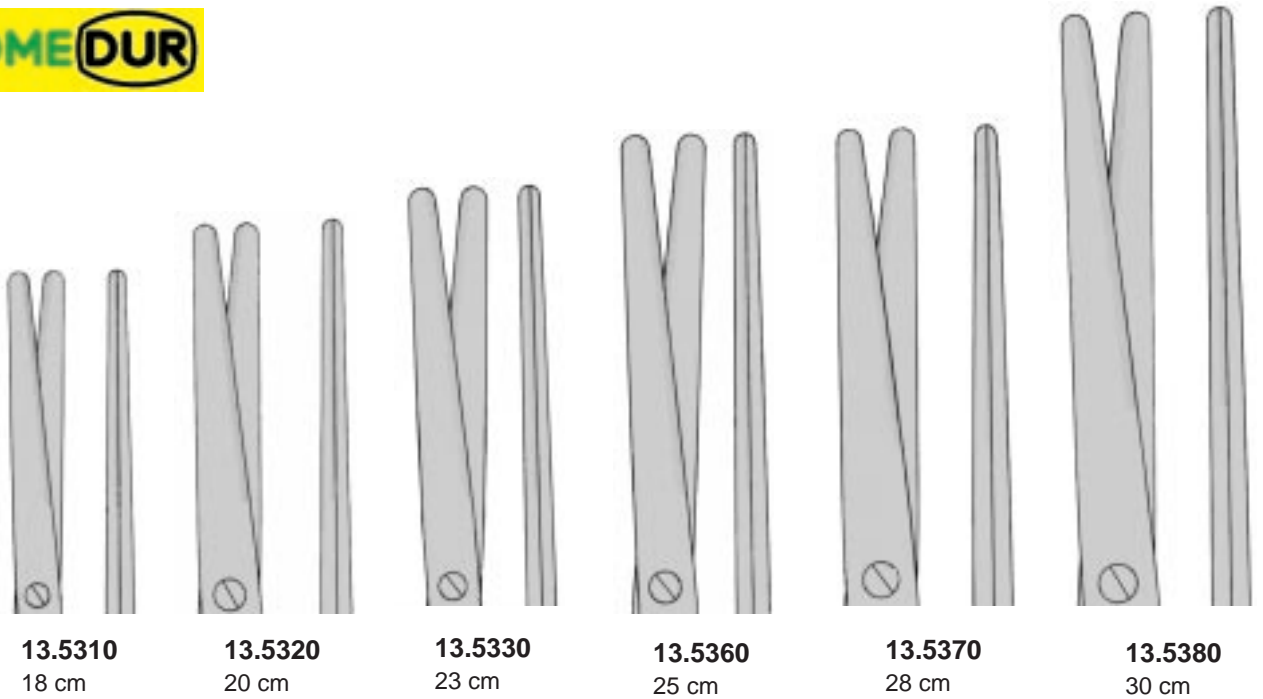

13.5310
18 cm

13.5320
20 cm

13.5330
23 cm

13.5360
25 cm

13.5370
28 cm

13.5380
30 cm



METZENBAUM

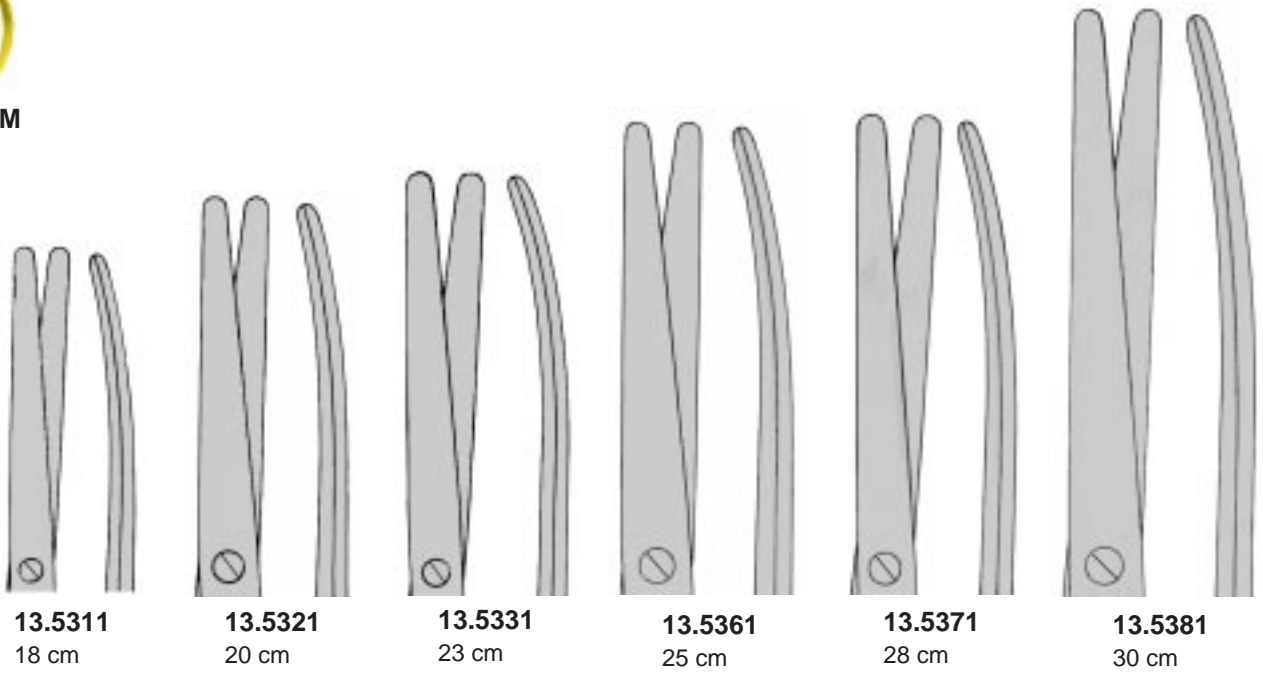

13.5311
18 cm

13.5321
20 cm

13.5331
23 cm

13.5361
25 cm

13.5371
28 cm

13.5381
30 cm



METZENBAUM-FINO

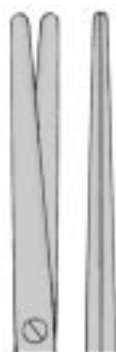

13.5304
14,5 cm

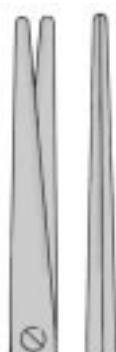

13.5314
18 cm



13.5324
20 cm

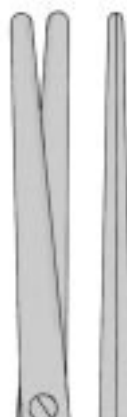

13.5334
23 cm



13.5364
25 cm



13.5374
28 cm



METZENBAUM-FINO



13.5305
14,5 cm



13.5315
18 cm



13.5325
20 cm



13.5335
23 cm



13.5365
25 cm

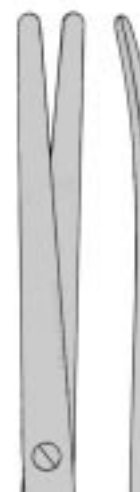

13.5375
28 cm

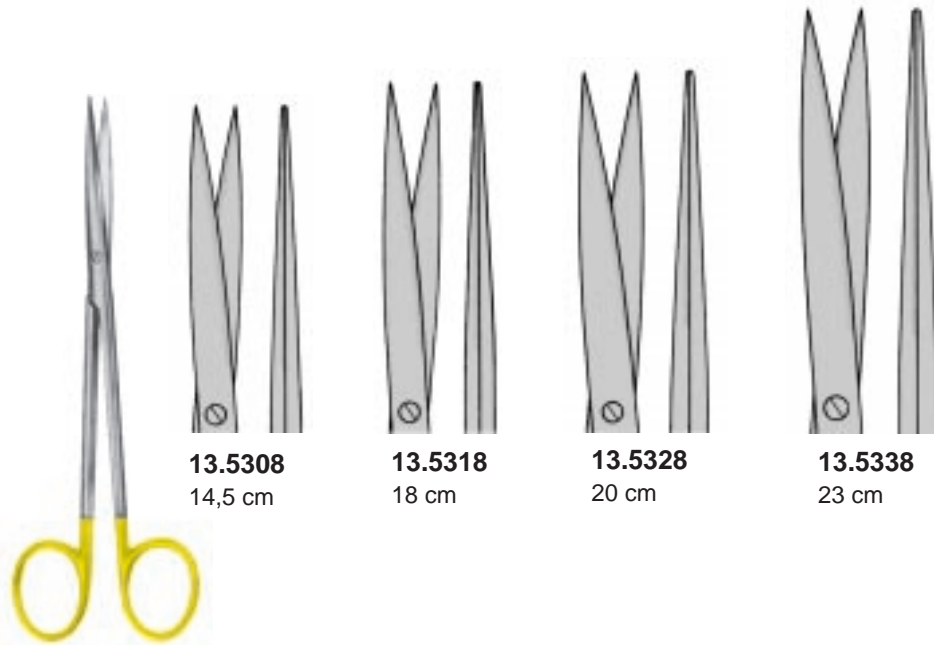

13.5308
14,5 cm

13.5318
18 cm

13.5328
20 cm

13.5338
23 cm

METZENBAUM X-FINO

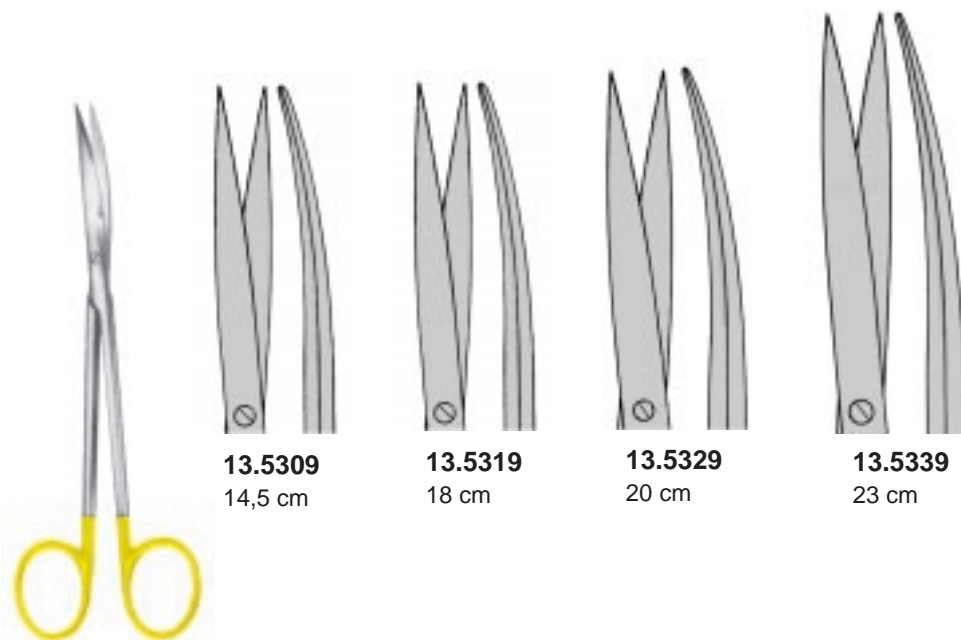

13.5309
14,5 cm

13.5319
18 cm

13.5329
20 cm

13.5339
23 cm

METZENBAUM X-FINO



METZENBAUM-FINO

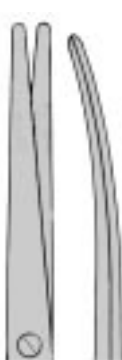

13.5313
18 cm



13.5323
20 cm



13.5333
23 cm



METZENBAUM-FINO



13.5317
18 cm



13.5327
20 cm



13.5337
23 cm



POTTS-SMITH

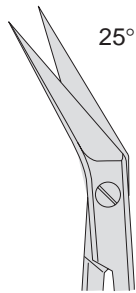

POTTS-SMITH
 13.5600 19 cm

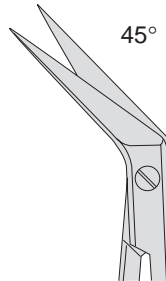

POTTS-SMITH
 13.5601 19 cm

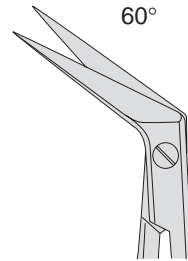

POTTS-SMITH
 13.5602 19 cm



DEBAKEY

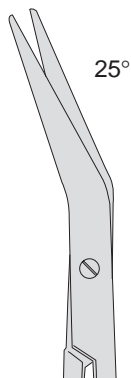

DEBAKEY
 13.5610 19 cm
 13.5620 23 cm
 13.5630 28 cm

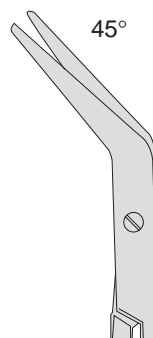

DEBAKEY
 13.5611 19 cm
 13.5621 23 cm
 13.5631 28 cm

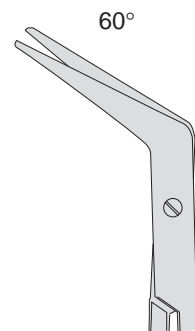

DEBAKEY
 13.5612 19 cm
 13.5622 23 cm
 13.5632 28 cm



13.5800

13.5801

KELLY
16 cm

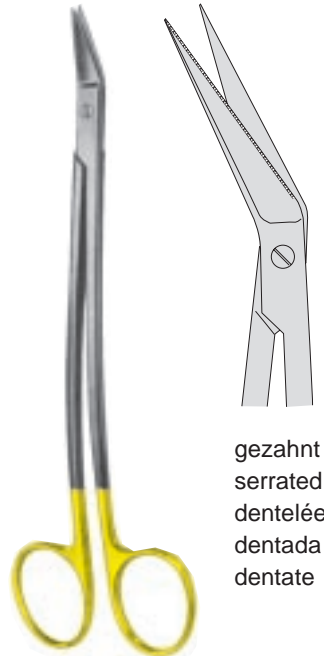

gezahnt
serrated
dentelée
dentada
dentate

LOCKLIN
13.5813
16 cm



DEAN
13.5901 17 cm
glatt / smooth / lisse / lisa / liscio
13.5903 17 cm
gezahnt / serrated / dentelée
dentada / dentate



gezahnt
serrated
dentelée
dentada
dentate

LIGATUR
13.2393W 14,5 cm
13.2394W 18,0 cm
13.2395W 20,0 cm
13.2396W 23,0 cm
13.2397W 25,0 cm



UNIVERSAL
13.5401
12,5 cm



SMITH
13.5410
16 cm



LISTER

- 21.0200 9,0 cm
- 21.0202 11,5 cm
- 21.0204 14,0 cm
- 21.0205 15,5 cm
- 21.0206 18,0 cm
- 21.0208 20,0 cm

21.0206L 18,0 cm
 linkshändig/left-handed/
 pour gaucher/para zurdo/
 per mano sinistra



LISTER-EXCENTRIC

- 21.0210 16 cm
- 21.0212 19 cm

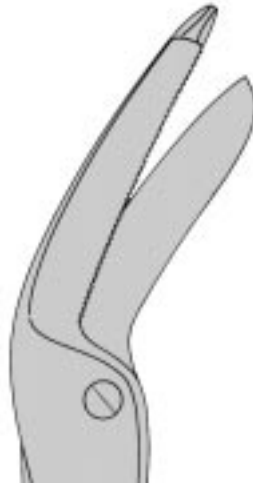

LISTER

- 21.0216 18 cm

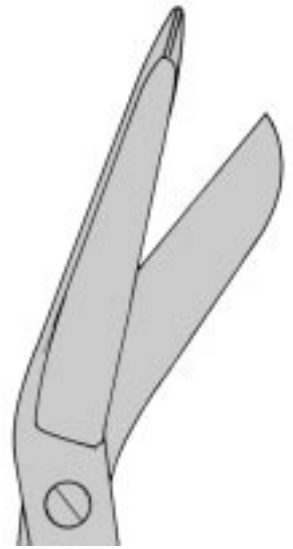

LISTER

- 21.0226 18 cm
- 21.0228 21 cm



KNOWLES

- 21.0230 14 cm



LORENZ

- 21.0241 23 cm





ESMARCH
21.0250 20 cm
21.0252 22 cm



BERGMANN
21.0260 23 cm



SMITH
21.0270 18 cm
21.0272 20 cm
21.0274 23 cm



UNIVERSAL
21.0280 15 cm



UNIVERSAL
21.0300 18 cm



UNIVERSAL
21.0310 15 cm



STILLE
21.0500 24 cm



STILLE
21.0510 23 cm
21.0512 26 cm
21.0514 37 cm



BRUNS
21.0540 23 cm
glatt/smooth
lisse/lisa/liscio
21.0545 23 cm
gezahnt/serrated
dentelée/dentadas/
dentate



BRUNS
21.0550 23 cm



WALTON
21.0560 20 cm



SEUTIN
21.0580 23 cm